

**TLR3168
Time-Lapse VCR**

**Installation/
Operation Manual**

C673M (2/01)

CONTENTS

Section	Page
GENERAL	5
SAFEGUARDS, WARNINGS, CAUTIONS, AND CARE	6
UNPACKING INSTRUCTIONS	8
INTRODUCTION TO TIME-LAPSE RECORDERS	8
TLR3168 FEATURES AND FUNCTIONS	9
QUICK START	10
BASIC START	10
ADDITIONAL ITEMS	10
INSTALLATION	11
PRE-INSTALLATION CAUTIONS	11
SECURING THE VCR CONTROLS	11
MONITOR TIPS	11
INSTALLATION	12
CONNECTING THE VCR TO A MULTIPLEXER	13
ALARM RECORDING CONNECTION	14
CONNECTING FOR SERIES RECORDING	14
CONNECTING FOR REMOTE RECORDING	14
CONNECTING FOR SYNCHRONOUS RECORDING	15
CONNECTING FOR EXTERNAL TIME CLOCK ADJUSTMENT	15
CONNECTING THE VCR TO A PC	16
CONNECTING TO A PC FOR REMOTE CONTROL	16
CONTROLS	18
FRONT PANEL	18
FLUORESCENT DISPLAY	20
REAR PANEL	22
ADJUSTING THE CLOCK AND USING THE JOG AND SHUTTLE CONTROLS	23
JOG AND SHUTTLE CONTROLS	23
USING THE JOG DIAL	23
USING THE SHUTTLE RING	23
ADJUSTING THE CLOCK	24
ADJUSTING TO THE EXACT SECOND	24
PROGRAMMING	25
GENERAL PROGRAMMING INSTRUCTIONS	25
LANGUAGE SELECTION MENU	25
QUICK GUIDE TO THE MENU STRUCTURE	26
MAIN MENU	27
DISPLAY MENU	27
DISPLAY MODE	27
TIME/DATE SIZE	27
BLUE BACK	27
TIMER PROGRAM	28
RECORDING SET UP MENU	29
REAR TERMINAL MENU	30
MAINTENANCE MENU	32
FIRST TIME SET UP MENU	32
RS-232C MENU	33
ADDITIONAL MATERIAL	33
DAY AND TIME DISPLAY MODES	33
SET THE DAY AND TIME	34
LOADING, UNLOADING, PROTECTING THE TAPE CASSETTE	35
LOADING	35
UNLOADING	36
PREVENTING ACCIDENTAL ERASURE	36
DAMAGED CASSETTE TAPE	36
WHEN TO REPLACE A TAPE	36
RECORDING	37
MANUAL RECORDING	37
RECORDING MODE	38
RECORDING CHECK FUNCTION	38
AUDIO RECORDING/PLAYBACK	38
REPEAT RECORDING	38
SERIES RECORDING	39
REMOTE RECORDING	40

ONE-SHOT/INTERVAL RECORDING	40
SYNCHRONOUS RECORDING	41
TIMER RECORDING	42
PROGRAMMING PROCEDURE	42
HOLIDAY SET UP	43
SPECIAL DW SETTING	43
OVERLAPPING PROGRAMS	43
WHAT IF THE TIMER RECORDING INDICATOR STARTS FLASHING?	43
ALARM RECORDING	44
ALARM RECORDING CONNECTION	44
PROGRAMMING FOR ALARM RECORDING	45
RECORDING AFTER A POWER FAILURE	46
MAINTENANCE	46
POWER LOSS LIST	46
VIEWING THE POWER LOSS LIST	46
CLEARING THE POWER LOSS LIST	46
ALARM LIST	47
VIEWING THE ALARM LIST	47
CLEARING THE ALARM LIST	47
ALL MENU INITIALIZE (RESET)	47
ELAPSED TIME AND REPEAT RECORDING TIMES DISPLAY	48
PLAYBACK	49
PLAYBACK PROCEDURE	49
PLAYBACK MODE	50
AUDIO PLAYBACK	50
END OF TAPE	50
SPECIAL EFFECTS PLAYBACK	50
STILL PICTURE	50
FRAME-BY-FRAME PLAYBACK	50
SHUTTLE RING	51
DIRECT SHUTTLE RING	51
ADJUSTING THE PICTURE DURING PLAYBACK	52
TRACKING ADJUSTMENT	52
ADJUSTING PICTURE QUALITY	52
VERTICAL (VIBRATION) ADJUSTMENT	53
SEARCH TECHNIQUES	54
COUNTER MEMORY STOP	54
SKIP SEARCH	54
INDEX SEARCH	55
HOW TO COUNT THE INDEX NUMBER	55
TIME AND DATE SEARCH	56
ADDITIONAL FUNCTIONS AND FEATURES	57
COUNTER	57
TAPE COUNTER	57
COUNTER RESET	57
COUNTER MEMORY	57
MEMORY BACKUP IN CASE OF POWER FAILURE	57
RESET BUTTON	57
EXTERNAL TIME CLOCK ADJUSTMENT	57
HOW EXTERNAL TIME ADJUSTMENT WORKS	57
USING WITH A PC	58
ASSIGNING THE RS-S32C SETTINGS	58
COMMANDS FROM A PC	59
WHEN CONTROLLING ONLY ONE VCR	59
WHEN CONTROLLING MULTIPLE VCRS	60
COMMANDS AND RESPONSES CHART	62
ERROR CODES	68
TESTING	68
INITIAL SYSTEM TESTING	68
REGULAR SYSTEM TESTING	68
TROUBLESHOOTING	69
SELF-DIAGNOSTIC FUNCTION AND WARNING DISPLAY	69
BEFORE CALLING FOR SERVICE	70
SPECIFICATIONS	72
INDEX	74
REGULATORY NOTICES	76
WARRANTY AND RETURN INFORMATION	76



LIST OF ILLUSTRATIONS



Figure	Page
1	Typical System Setup 12
2	Connecting a VCR to a Multiplexer 13
3	Alarm Recording Connection 14
4	Connecting VCRs for Series Recording 14
5	Connecting for Remote Recording 14
6	Connecting for Synchronous Recording 15
7	Connecting for External Time Clock Adjustment 15
8	VCR to PC Connection 16
9	Front Panel 18
10	Fluorescent Display 20
11	Rear Panel 22
12	JOG Dial and SHUTTLE Ring 23
13	Language Menu 25
14	Menu Tree 26
15	Main Menu 27
16	Display Menu 27
17	Timer Program Illustration 28
18	Recording Set Up Menu 29
19	Rear Terminal Menu 30
20	First Time Set Up Menu 32
21	RS-232C Menu 33
22	Synchronous Recording Sequence 41
23	VCR Switches to Alarm Mode 44
24	Maintenance Menu 46
25	Playback Controls 49
26	Shuttle Ring Speed Settings 51
27	Direct Shuttle Ring Speed Settings 51
28	Tracking Adjustment 52
29	Picture Quality Adjustment 52
30	Vertical Picture (Vibration) Adjustment 53
31	Skip Search 54
32	Index Searching 55
33	Commands When Controlling One VCR 59
34	Commands When Controlling Multiple VCRs 60

LIST OF TABLES

Table	Page
A	RS-232C Protocol 16
B	Call Out/Tape End 30
C	Tape Replacement by Use 36
D	Recording/Playback Times 38
E	Action When Tape End Is Reached by Setting 39
F	Numbers of VCRs and Cameras 41
G	Minimum Interval Between Recordings 44
H	Audio Playback and Picture Quality 50
I	End of Tape Actions 50
J	Warning Display and Actions 69
K	Tape Speed and Recording Time 73

GENERAL

	WARNING RISK OF ELECTRIC SHOCK DO NOT OPEN	
<p>WARNING: TO REDUCE THE RISK OF ELECTRIC SHOCK DO NOT REMOVE COVER (OR BACK) NO USER-SERVICEABLE PARTS INSIDE REFER SERVICING TO QUALIFIED SERVICE PERSONNEL.</p>		

	AVERTISSEMENT DANGER D'ÉLECTROCUTION NE PAS OUVRIR	
<p>AVERTISSEMENT: POUR ÉLIMINER TOUT RISQUE D'ÉLECTROCUTION, NE PAS OUVRIR LE COUVERCLE (OU LA PARTIE ARRIÈRE). AUCUNE PIÈCE RÉPARABLE PAR L'UTILISATEUR NE SE TROUVE À L'INTÉRIEUR. POUR TOUTE INTERVENTION D'ENTRETIEN OU DE RÉPARATION SE CONFIER AUX TECHNICIENS QUALIFIÉS.</p>		

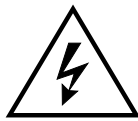

The lightning flash with arrowhead symbol, within an equilateral triangle, is intended to alert the user to the presence of uninsulated dangerous voltage within the product's enclosure that may be of sufficient magnitude to constitute a risk of electric shock.



La flèche symbolisant l'éclair dans un triangle équilatéral a pour objet de tirer l'attention de l'utilisateur sur le fait, qu'il y a des tensions dangereuses non-isolées à l'intérieur de l'enceinte du produit qui peuvent être suffisamment impor-tantes pour conduire au risque d'électrocution.



The exclamation point within an equilateral triangle is intended to alert the user to the presence of important operating and maintenance (servicing) instructions in the literature accompanying the equipment.



Le point d'exclamation au sein d'un triangle équilatéral a pour objet de tirer l'attention de l'utilisateur sur le fait qu'il y a des instructions de mise en service et d'entretien (de réparation) dans les fiches descriptives de l'appareil qui doivent obligatoirement être respectées.

WARNING:

TO PREVENT FIRE OR SHOCK HAZARD, DO NOT EXPOSE THIS EQUIPMENT TO RAIN OR MOISTURE.

CAUTION:

TO PREVENT ELECTRIC SHOCK DO NOT USE THE POLARIZED PLUG WITH AN EXTENSION CORD, RECEPTACLE OR OTHER OUTLET UNLESS THE BLADES CAN BE FULLY INSERTED TO PREVENT BLADE EXPOSURE.

AVERTISSEMENT:

AFIN D'ÉVITER TOUT RISQUE D'INCENDIE OU D'ÉLECTROCUTION, NE PAS EXPOSER CET APPAREIL À LA PLUIE NI À L'HUMIDITÉ.

ATTENTION:

POUR PRÉVENIR LES CHOCS ÉLECTRIQUES NE PAS UTILISER CETTE FICHE POLARISÉE AVEC UN PROLONGATEUR, UNE PRISE DE COURANT OU UNE AUTRE SORTIE DE COURANT, SAUF SI LES LAMES PEUVENT ÊTRE INSÉRÉES À FOND SANS EN LAISSER AUCUNE PARTIE À DÉCOUVERT.

SAFEGUARDS, WARNINGS, CAUTIONS, AND CARE

WARNING: *The included power cord is used for 120 VAC, 60 Hz. Never connect any outlet or power supply having a different voltage or frequency. If you are unsure of the type of power supply, consult your equipment dealer or local power company.*

Observe the following WARNINGS before installing and using this product. Follow all warnings and instructions marked on the VCR.

Instructions

Read all the safety and operating instructions before operating the VCR. Keep the instructions for future reference. Follow all operating and use instructions. Heed all warnings on the equipment and in the operating instructions.

Tapes

Only video cassette tapes with the VHS mark may be used with this model.

Power Source and Power Cord

Do not damage the power cord—it may cause fire or shock hazard. Route the cord so it will not be walked on or pinched by items placed on or against it. Pay particular attention to the cord at the wall plug or convenience receptacle and the point where it connects to the VCR. When unplugging the power cord, grasp the plug and remove it carefully.

Installation/Service

Installation and servicing should be done by qualified service personnel only and conform to all local codes. Do not try to service the VCR yourself. Opening or removing covers may expose you to dangerous voltage or other hazards.

Damage Requiring Service

Unplug the VCR from the wall outlet and refer servicing to qualified service personnel under the following conditions:

- When the power cord or plug is damaged.
- If liquid has been spilled or objects have fallen into the VCR.
- If the VCR does not operate normally when following the operating instructions.

Adjust only those controls covered by the operating instructions. Improper adjustment of other controls may cause damage and will often require extensive work by a qualified technician to restore the VCR to normal operation.

- If the VCR was dropped or the cabinet damaged.
- When the VCR shows a distinct change in performance. This indicates a need for service.

Replacement Parts

Be sure the service technician uses only replacement parts Pelco recommends, or which have the same characteristics as the original part. Unauthorized substitutions may cause fire, electric shock, or other hazards.

Safety Check

When service or repair to the VCR is completed, ask the service technician to perform safety checks to ensure it is in safe operating condition.

Water/Moisture/Condensation

Do not use this VCR near water. It is designed for indoor use only and must not be installed where exposed to rain and moisture.

Do not place objects containing water, such as drinks, on top of the VCR. If the VCR is exposed to a rapid increase in temperature (such as warming a cold room or after moving it from a cold location to a warm one), condensation may form on the tape transport mechanism inside the VCR. To prevent damage to the VCR or tapes, plug the VCR into the AC outlet and turn the power on for about two hours. Do not play back or record on the VCR during this time.

Condensation is likely to occur when:

- The VCR is moved from a cold room to a warm room or from outdoors to indoors.
- A cold room is heated quickly.
- The humidity is very high.

Avoid using the VCR where cold air (such as from an air conditioner) will blow directly on it.

Cleaning

Unplug the VCR from the wall outlet before cleaning. Do not use liquid or aerosol cleaners. Clean with a soft cloth slightly moistened with mild detergent and water. Wipe dry. NEVER use petroleum-based solutions.

Attachments

Do not use attachments not recommended by Pelco as they may cause hazards.

Accessories

Use only with a cart, stand, tripod, bracket, or table recommended by Pelco or sold with the VCR. Follow Pelco's instructions when mounting equipment, and use a mounting accessory recommended by Pelco.

Do Not Place Anything Heavy On The VCR

Heavy objects placed on the VCR will damage it.

Ventilation

Slots and openings in the cabinet provide ventilation and prevent it from overheating. Do not block these openings. Never place the VCR near or over a radiator or heat register. Do not place it in a built-in installation such as a rack unless proper ventilation is provided or Pelco's instructions have been followed. There are many ventilation holes on the bottom of the VCR—for maximum ventilation, place it on a hard level surface only.

Grounding or Polarization

This VCR has a three-wire grounding-type plug—a plug with a third (grounding) pin. As a safety feature, this plug fits only into a grounding-type outlet. If you cannot insert the plug into the outlet, contact an electrician to replace the obsolete outlet.

Lightning/Power Surges

Unplug the VCR for additional protection during lightning storms or when it is unused for long periods. Pelco recommends using conditioned-output uninterruptible power supplies (UPS) and/or surge protected outputs to maximize protection of the VCR.

When Not In Use

When you finish operating the VCR, always unload the cassette and turn off the power.

Overloading

Do not overload wall outlets and extension cords as this increases the risk of fire and electric shock.

Foreign Objects

Never push objects of any kind into the VCR through openings. They may touch dangerous voltage points or short out parts that could cause a fire or electric shock, or damage the mechanism.

Care of Video Cassette Tape

- Avoid violent vibration and shock.
- Do not place near a strong magnetic field (near a motor, transformer, or magnet).
- Never place or store in direct sunlight.
- Avoid dusty places.
- Place the cassette in the cassette case and store vertically.
- Never store tapes in humid locations.

UNPACKING INSTRUCTIONS

Unpack and inspect all parts carefully. Save the shipping carton, boxes, and inserts. They are the safest material in which to make future shipments.

If an item appears damaged in shipment, replace it properly in its box and contact the factory at 1-800-289-9100 or 1-559-292-1981 for a replacement. (International customers fax 1-559-348-1120 for authorization and instructions.)

If an item needs to be returned to the factory for repair, consult the WARRANTY AND RETURN section of this manual for instructions.

INTRODUCTION TO TIME-LAPSE RECORDERS

Time-lapse recording permits longer than ordinary recording times. The primary reason for using time-lapse recording in a CCTV security system is that a single VCR tape can be used for an extended period beyond the standard recording time. The following explains how time-lapse recording works.

The actual recording on VCRs is a series of still pictures or fields. Standard consumer VHS recorders store 60 fields (30 frames) per second. A T-120 cassette lasts just two hours in this mode (SP mode). You can get slightly longer recording times (six hours) using the extended recording mode (EP mode). You can record even longer on a T-160 cassette in these modes: two hours and 40 minutes in SP mode and eight hours in EP mode. (Refer to Table D for actual recording times in different modes.)

Time-lapse recorders, however, use microprocessor-based techniques to record fewer fields per second than a normal VHS machine and extend record time. This negates the need to change the tape every two hours—and also substantially reduces viewing time when the recording is played back, another important consideration.

In normal VCR operation, all video head scans (60 per second) are recorded. But in time-lapse mode the tape runs more slowly and records pictures periodically. In 12-hour mode, a normal time-lapse machine records 10 fields per second, and in 24-hour mode, it stores just five fields per second (for up to 12 and 24 hours on a tape, respectively). Longer times are possible by slowing the recording rate further.

At normal speed a picture is recorded every 1/60 of a second so there is little change over five frames. In longer time-lapse modes, however, a field is recorded intermittently over a longer period so changes are apparent from field to field.

The time-lapse recording can be played back at normal two-hour tape speed, which makes for rapid review—one of the time-lapse recorder's most important advantages. Action on the tape, however, appears faster than normal.

As an advanced feature, time-lapse recorders (like the TLR3168) can automatically switch from time-lapse to real-time recording when an alarm condition occurs. This is important since the primary purpose of recording an event is identification, and real-time recording provides more detail.

TLR3168 FEATURES AND FUNCTIONS

The TLR3168 Time-Lapse VCR is a powerful surveillance tool designed for industrial and security recording. The unit supports both T-120 and T-160 tapes.

- **T-120 Tapes**
The unit can record for 6, 18, 30, 48, 72, 96, 120, or 168 hours.
- **T-160 Tapes**
The unit can record for 8, 24, 40, 64, 96, 128, 160, or 224 hours.

The TLR3168 features frame-by-frame and field-by-field playback and high-speed search. Playback also allows still picture viewing.

Audio Recording—The 6H, 8H, L18H, L24H, L30H, and L40H modes allow audio recording.

Resolution and Image Quality—This VCR has a horizontal resolution of more than 240 lines in VHS mode and more than 400 lines in super resolution mode.

Remote Operation by PC via RS-232—You can use a personal computer that has an RS-232 serial port to remotely control the VCR.

Automatic Head Cleaning—This VCR automatically removes foreign matter from the heads when a cassette is inserted for continuous smooth operation.

Easy Setup Using a Monitor—The on-screen menus simplify setup programming.

Easy Cueing with Alarm Recording—Index signals are automatically added at the beginning of alarm recording for easy cueing. You can even use the monitor to confirm an alarm recording's starting time.

External Time Clock Adjustment—You can reset the on-screen clock to the nearest hour by applying a signal to the RST (reset) IN terminal at the rear of the VCR.

One-Button Recording Check—You can confirm correct recording by pressing the PLAY/REC CHECK button during recording.

Variety of Search Functions—You can do index and skip searches, or search by time and date.

Special Playback Features—These include still images, speed search, reverse playback, frame-by-frame and field-by-field viewing in both directions, slow-motion, and high-speed viewing.

JOG Dial/SHUTTLE Ring—You can use these controls to search for the desired image. You can adjust the playback speed with the SHUTTLE ring and search for an image frame-by-frame with the JOG dial.

Recording Options—This system offers the following recording options: daily/weekly/holiday timer recording, alarm recording, series recording, remote recording, repeat recording, one shot/interval recording, and synchronous recording.

Complete or Partial Front Panel Lock—All or some of the front panel buttons can be locked, keeping the VCR in its current condition.

Protection Against Power Failures—Recording data (including date, time, and timer setup) is stored in backup memory, so the system can resume recording after a power failure. The monitor displays the time of the failure.

Digital Elapsed Time Display—The elapsed time of recording and playback is stored in non-volatile memory. You can use the elapsed time display as a guide to when to do periodic maintenance.

Tape Use Counter—This counter displays how many times you have recorded on a tape. This helps you decide when you need to replace a tape.

Daylight Savings Time Setting—A daylight savings time setting is available. You can set the clock forward an hour by programming the menu.

NOTE: *The battery backup is for memory only—the VCR does not continue recording if the power goes out. If you want to keep recording during an outage, make sure the VCR system is on your UPS (uninterruptible power supply) system.*

QUICK START

BASIC START

NOTE: This section is intended for people experienced in working with time-lapse recorders and installing CCTV systems. (However, you might want to take a few minutes to review the material in the General section.)

1. Decide where to locate the VCR. Do all system hookups first (camera, multiplexer, etc.) if you are installing the VCR where you cannot access its rear panel.
2. Connect the VCR to other equipment (refer to the *Installation* and *Connecting the VCR to a Multiplexer* sections.)
3. Set the time and date with the power off by pressing the MENU button for more than three seconds and then adjusting the time and date on the fluorescent display. (Refer to the *Adjusting the Clock* section.) Skip if you do not want to set the time and date.
4. Plug in the VCR and press the POWER button.
5. Insert a T-120 or T-160 tape. Refer to Table D for recording times.
6. Put the VCR in the recording mode you want by pressing the REC/PLAY MODE + and – buttons. Watch the fluorescent display. Set the recording speed to 6H, L18H, L30H, 48H, 72H, 96H, 120H, 168H, or 0H for T-120 tape or to 8H, L24H, L40H, 64H, 96H, 128H, 160H, 224H, or 0H for T-160 tape.
7. Press REC to begin recording. Press STOP to stop.
8. Turn the SHUTTLE ring right to fast forward and left to rewind. Press STOP to stop. Press PLAY to play back the tape.
9. Refer to the *Initial Testing* section for information on testing.

ADDITIONAL ITEMS

You can also incorporate the following programming steps for more than a basic quick setup.

- If desired, set the tape end and quasi v-sync options (refer to the *First Time Set Up Menu* section).
- If desired, set the display mode and time and date size options (refer to the *Display Menu* section).
- If desired, program for timer recording (refer to the *Recording Set Up Menu* section).
- If desired, program for alarm recording mode and duration (refer to the *Recording Set Up Menu* section).
- If desired, refer to the *Rear Terminal Menu* section to program for call out (refer to the *Series Recording* section), clock out, operation of the mode out terminal, and operation mode of the REC IN terminal.

INSTALLATION

PRE-INSTALLATION CAUTIONS

- Provide secure power to system components. Prevent overloading or shorting by dedicating power circuits to the surveillance equipment. Restrict access to the surveillance system circuit breakers, switches, and equipment power cords.
- If you need to record multiple cameras, a multiplexer is required.
- Surveillance system components must be operationally compatible. Time-lapse recording speeds and dwell times of any accessory switching equipment must be compatible with each other.
- The TLR3168 Time-Lapse VCR provides multiple alarm recording speeds so it is important that alarm triggering of components be operationally compatible. Refer to the *Introduction to Time-Lapse Recorders* section for information on time-lapse recording.
- Complete all system hookups (cameras, multiplexer, etc.) before installing the VCR where you cannot access its rear panel.
- Do not connect color and black and white cameras together.

SECURING THE VCR CONTROLS

Protect surveillance equipment to forestall tampering. We recommend putting the recorder in a secure VCR cabinet. Pelco offers such units—the RM2001, which is a rack kit for a single VCR.

MONITOR TIPS

- Pelco recommends using a CCTV monitor.
- Some monitors may cause picture vibration or picture distortion at the top or bottom of the image during still or normal playback. (Refer to the *Vertical Adjustment* section for information.)
- A television may be unable to provide a stable picture without vibration or distortion.

INSTALLATION

1. Remove the VCR and all cables from the box.
2. Place the VCR in a suitable location.
3. If installing in a rack, place the VCR in the rack before making cable and power connections. Refer to the documentation included with the rack kit for installation instructions.
4. If you are not using a multiplexer, refer to Figure 1.
 - Connect the camera (video output) to the rear of the VCR (video input BNC). Connect the VCR (video output BNC) to the monitor (video input).
 - Connect the alarm input to the VCR (ALM IN and GND [ground] terminals).
 - If you are using a 600-ohm microphone, connect it to the VCR (MIC jack). Connect the VCR (AUDIO OUT connector) to the monitor (audio input).
5. If you are using a multiplexer, refer to the *Connecting the VCR to a Multiplexer* section.

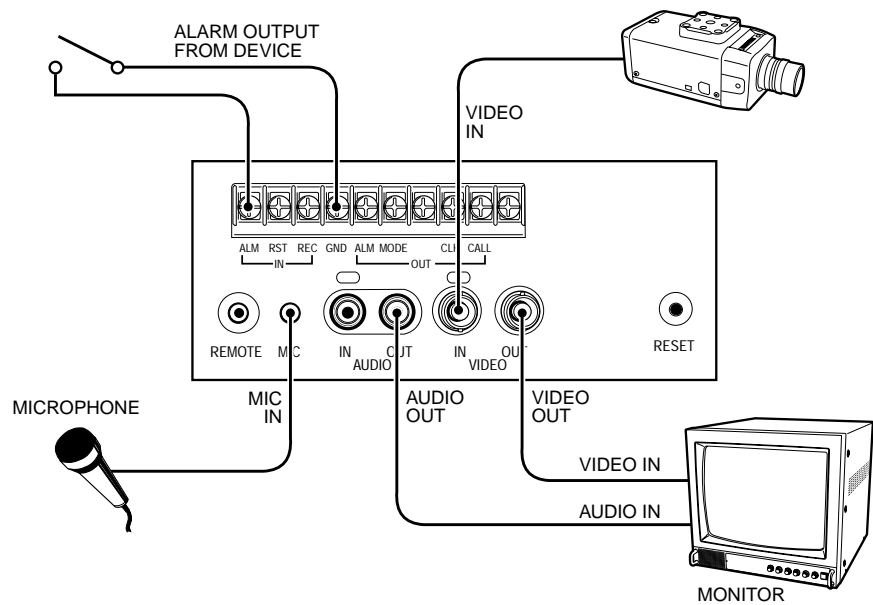

Figure 1. Typical System Setup

00429

CONNECTING THE VCR TO A MULTIPLEXER

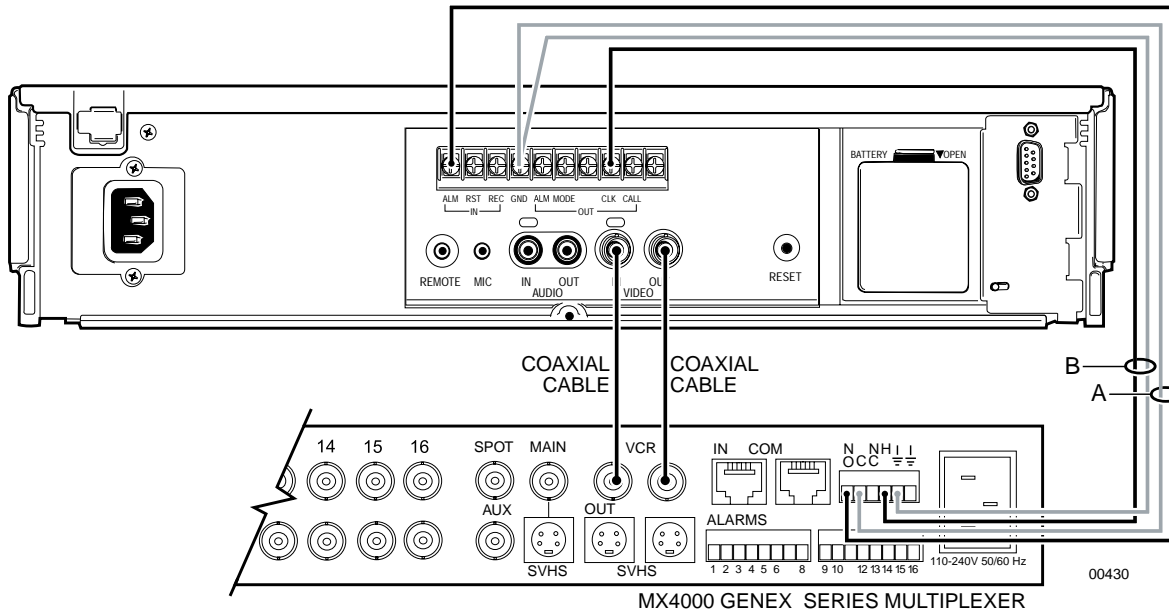

Figure 2. Connecting a VCR to a Multiplexer

NOTE: Cameras and monitors are connected to the multiplexer. Figure 2 shows the connection between the VCR and an MX4000 Series Genex Multiplexer. Refer to the multiplexer manual for additional component connections.

Figure 2 shows how to connect the VCR to an MX4000 Series Genex® Multiplexer.

- For Automatic Speed Tracking (“B” lines in Figure 2)

This lets the VCR control the multiplexer’s recording speed. It is the most efficient recording method.

 1. Connect the CLK output to the multiplexer’s head switching (HS) input to synchronize camera switching.
 2. Connect the multiplexer’s ground terminal to the VCR’s GND terminal.
- For Alarm Recording (“A” lines in Figure 2)

This is to start and stop recording when there are alarms.

 1. Connect the multiplexer’s normally open (N.O.) relay terminal to the VCR’s ALM IN (alarm input) terminal.
 2. Connect the common (C) terminal to the VCR’s GND terminal.

ALARM RECORDING CONNECTION

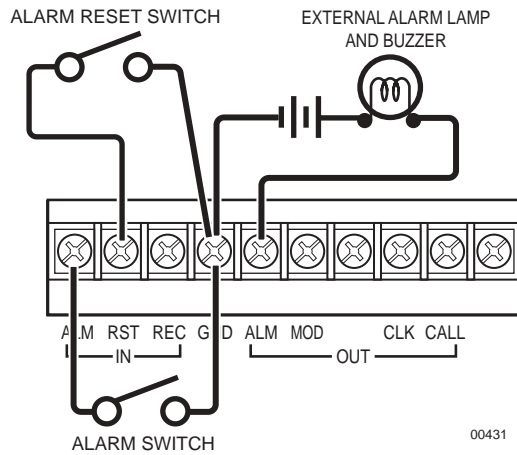

Figure 3. Alarm Recording Connection

You can confirm an alarm from a distance by connecting the ALM OUT terminal with an existing alarm system panel or other peripherals, such as a buzzer. Connect the VCR and other peripherals as shown in Figure 3.

CONNECTING FOR SERIES RECORDING

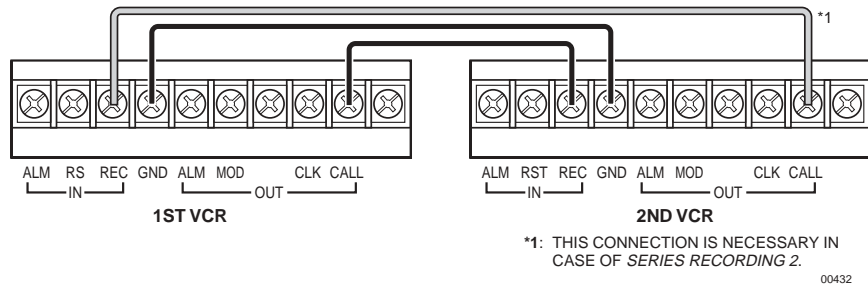

Figure 4. Connecting VCRs for Series Recording

Connect the VCRs as shown in Figure 4. Refer to the Series Recording section for information about series recording methods 1 and 2.

CONNECTING FOR REMOTE RECORDING

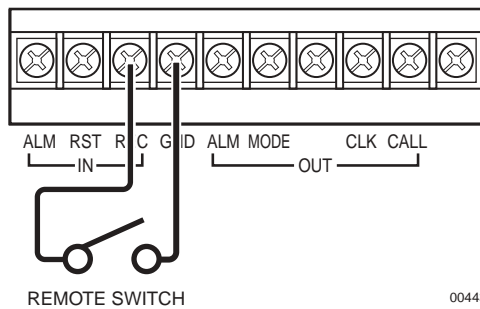
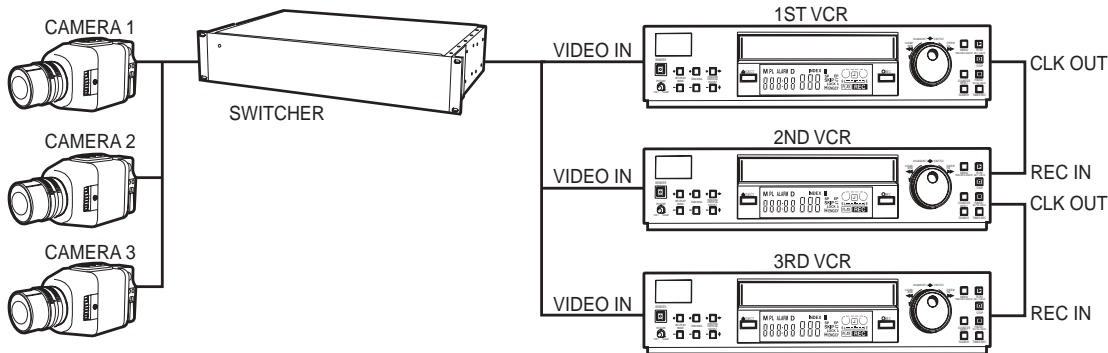

Figure 5. Connecting for Remote Recording

Connect the VCR with a remote switch as shown in Figure 5.

CONNECTING FOR SYNCHRONOUS RECORDING



00434

Figure 6. Connecting for Synchronous Recording

Connect the VCRs as shown in Figure 6. The number of VCRs varies according to the recording time mode selected.

CONNECTING FOR EXTERNAL TIME CLOCK ADJUSTMENT

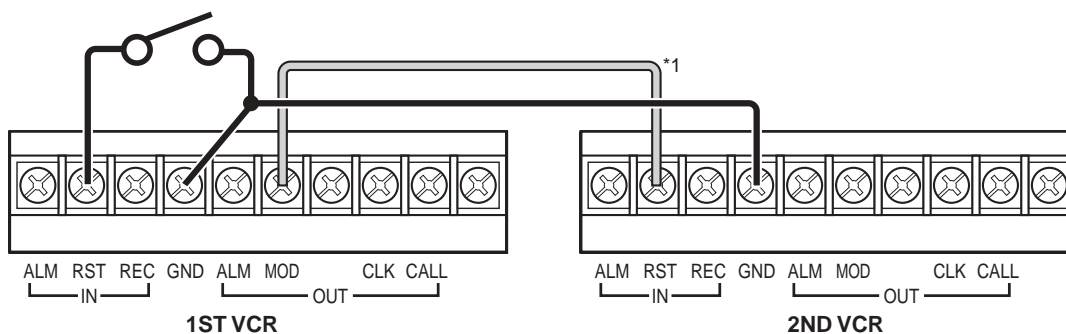

*1: WHEN CONNECTING THE **MODE OUT** TERMINAL OF THE FIRST VCR WITH THE **RST IN** TERMINAL OF THE SECOND VCR, THE ON-SCREEN CLOCK OF THE SECOND VCR CAN BE ADJUSTED TO THAT OF THE FIRST VCR.

00435

Figure 7. Connecting for External Time Clock Adjustment

Connect the VCRs as shown in Figure 7. When connecting the MODE OUT terminal of the first VCR to the RST IN terminal of the second VCR, the on-screen clock of the second VCR can be adjusted to that of the first VCR.

If ALARM REC DURATION in the Recording Set Up menu is set to other than MAN1, the on-screen clock can be reset to the nearest hour by applying a signal to the RST (reset) IN terminal. For example, if the current time is 11:29:59, it will be reset to 11:00:00, and if the current time is 11:30:00, it will be reset to 12:00:00.

CONNECTING THE VCR TO A PC

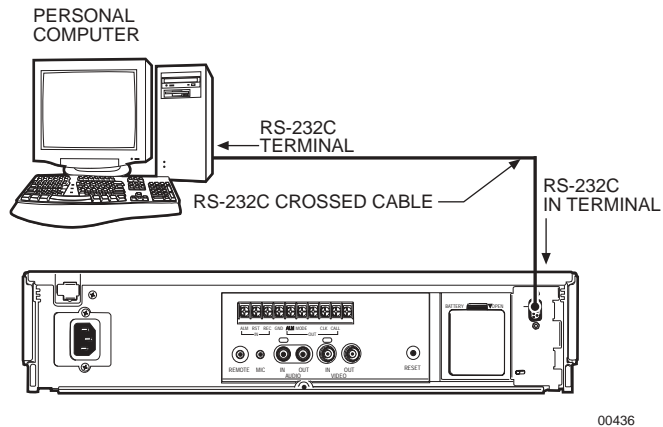

Figure 8. VCR to PC Connection

IMPORTANT: Before connecting the hardware, unplug the VCR's power cord from the wall outlet, and turn off the PC.

1. Connect the RS-232C cross cable to the PC's RS-232C terminal.
2. Connect the other end of the cable to the VCR's RS-232C terminal.

For instructions on how to set the RS-232C interface board setting, refer to the *Assigning the RS-232C Settings* section.

CONNECTING TO A PC FOR REMOTE CONTROL

You can remotely control the VCR using a personal computer that has an RS-232C serial port.

Physical Protocol of RS-232C

Table A. RS-232C Protocol

No.	Signal Line Names	Meanings	Directions (from VCR side)
2	RD	Receive data	INPUT
3	SD	Transmit data	OUTPUT
4	ER	Data terminal ready	OUTPUT
5	SG	Signal ground	--
6	DR	Data set ready	INPUT
7	RS	Request send	OUTPUT
8	CS	Clear to send	INPUT

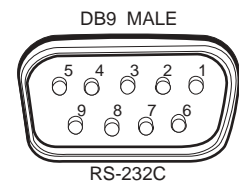

Data Communication Settings

Synchronization: Asynchronous
 Transmission rate: 1200/2400/4800/9600 bps
 Data bit length: 8bit/7bit
 Stop bit length: 1bit/2bit
 Parity bit: NONE/Even/Odd
 Xcontrol: Nil
 S parameter: Nil
 CS-RS handshake: With
 Delimiter code for send: CR(0DH)/CR(0DH)+LF(0AH)
 Delimiter code for receive: CR(0DH)/CR(0DH)+LF(0AH)

Cable Connections

Before connecting the hardware, unplug the VCR's power cord from the wall outlet, and turn off the PC. Connect the VCR's RS-232C IN terminal to the PC's serial port.

1. When the PC's RS-232C connector is DB25.

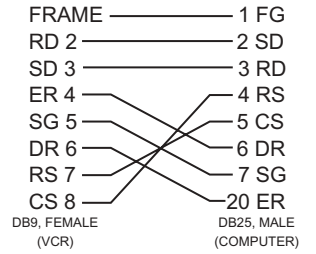

00438

2. When the PC's RS-232C connector is DB9.

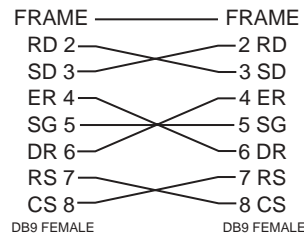

00439

CONTROLS

FRONT PANEL

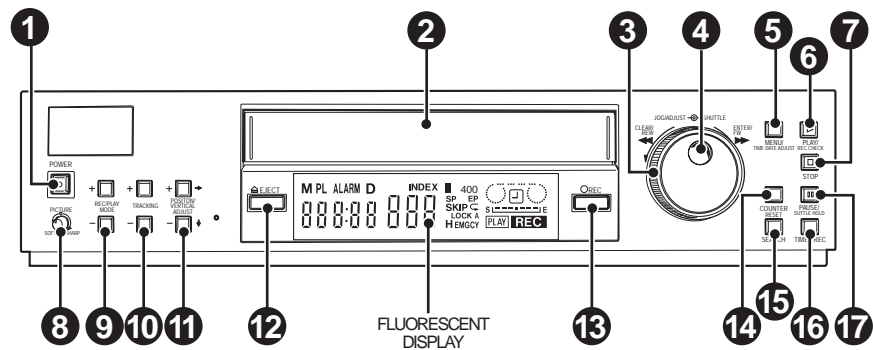

00440

Figure 9. Front Panel

1. **POWER button**
Press for on; press again for off. The POWER indicator lights when the VCR is turned on.
2. **Cassette loading slot**
Insert the cassette in this slot to load it.
3. **SHUTTLE ring**
Use to adjust the playback speed and to program the menus. Turn this ring to the right to advance the tape or to forward search. Turn it to the left to rewind a tape or to reverse search. You can also use it to clear the alarm list, timer recording, and to initialize the menu programming. It also lets you program or exit the menus after setup.
4. **JOG dial**
Use to advance or reverse the tape frame-by-frame and to program the menus.
5. **MENU/TIME DATE ADJUST button**
 - When the VCR is turned on, press to display the Main menu. Press again to exit the menu.
 - When the VCR is turned off, press for more than three seconds and you can adjust the VCR's time and date on the fluorescent display.
6. **PLAY/REC CHECK**
 - When the VCR is in stop mode, press to play back a previously recorded tape.
 - During recording, press for more than 1.5 seconds to check the recording function.
7. **STOP button**
Press to halt all tape-related functions.
8. **PICTURE control**
Use this control to adjust picture quality between soft and sharp.
9. **REC/PLAY MODE buttons (+/-)**
Press to select the recording or playback speed.
10. **TRACKING buttons (+/-)**
Press to reduce or eliminate the noise during playback, slow playback, etc.

11. **POSITION/VERTICAL ADJUST buttons (+/-)**
 - Pressing the (+) button moves the time and date display to the right. Pressing the (-) button moves the display down the screen. The display cannot be adjusted during an alarm recording or if a warning is displayed.
 - Pressing either button minimizes vertical jitter in still mode or during fast playback. Refer to the *Vertical Adjustment* section for details.
12. **EJECT button**

Press to remove the cassette.
13. **REC (record) button**

Press to begin recording.
14. **COUNTER RESET button**

Press to reset the counter to 00000.
15. **SEARCH button**

Press to access the Search Function menu.
16. **TIMER REC button**

Press to make a timed recording (once the VCR is programmed to record).
17. **PAUSE/SHUTTLE HOLD button**
 - Press during recording to temporarily stop tape movement. Press again to resume recording.
 - Press during playback for a still picture. Press again to resume normal playback.
 - Press and hold after turning the SHUTTLE ring to fix the playback speed.

FLUORESCENT DISPLAY

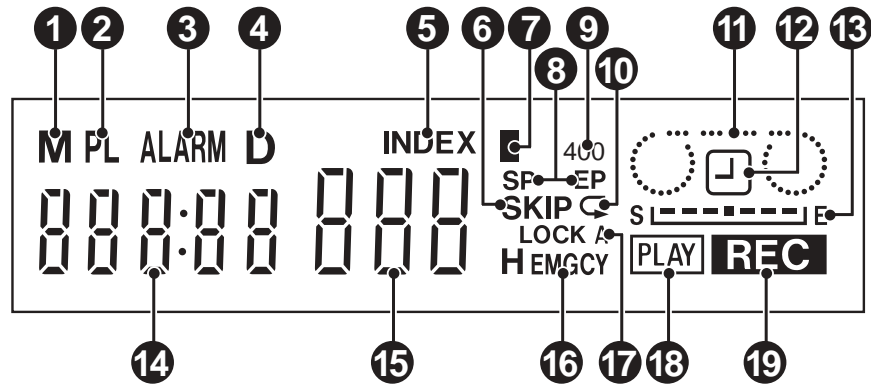

00441

Figure 10. Fluorescent Display

1. **M (counter memory stop/month) indicator**
 - Lights during counter memory stop.
 - Also, lights when the month (of time and date) is being entered through the front panel.
2. **PL (power loss) indicator**
Lights when the VCR is turned on after a power failure during recording.
3. **ALARM (recording) indicator**
Flashes during alarm recording and stays on when the alarm recording is finished.
4. **D (time and date search/day) indicator**
 - Lights during the time and date search.
 - Also, lights when the day (of time and date) is being entered through the front panel.
5. **INDEX (index search) indicator**
Flashes when recording an index signal, and lights during the index number setup and the index search. (Index number is shown on the Recording and Playback Mode display.)
6. **SKIP (skip search) indicator**
Lights during a skip search.
7. **Daylight savings time indicator**
Lights when DAYLIGHT SAVINGS is set to ON.
8. **SP, EP (tape speed) indicator**
Indicates the tape speed (SP = standard play, EP = extended play).
9. **400 (super resolution) indicator**
Lights during recording using VHS tape, during playback using VHS tape recorded in super resolution mode, and when a VHS tape recorded in super resolution mode is inserted in the VCR (provided SUPER RESOLUTION in the Recording Set Up menu is set ON).
10. **Repeat indicator**
Lights when TAPE END in the First Time Set Up menu is set to REPEAT or ALARM•PROT.
11. **Cassette Status indicator**
Lights when you insert a tape. The light advances, stops, or flashes according to tape movement.

12. **Timer Recording indicator**
Lights when the VCR is in standby for timer recording or during timer recording.
13. **Tape Remaining indicator**
Indicates the absolute position on the tape (S = start of tape, E = end of tape).
14. **Counter/Clock display**
 - With the VCR on, indicates the relative position on the tape. (The counter stops counting where no recording is made on the tape.)
 - With the VCR off, shows the clock (24-hour format).
15. **Recording and Playback Mode/Index Number display**
Displays the selected recording or playback mode. The mode shown varies by the TAPE LENGTH setting (T-120 or T-160) in the First Time Set Up menu. During an index number setup and index search, it displays the index number.
16. **EMGCY (emergency recording) indicator**
Lights when EMERGENCY REC in the Recording Set Up menu is set to ON.
17. **LOCK/LOCK A indicator**
 - Lock: Lights when all buttons except REC and EJECT are locked.
 - Lock A: Lights when all buttons are locked.
18. **PLAY indicator**
Lights during playback.
19. **REC (recording) indicator**
Lights during recording.

REAR PANEL

WARNING: The included power cord is used for 120 VAC, 60 Hz. Never connect the power cord to any output or power supply having a different voltage or frequency. Make sure the power cord is unplugged before making any rear panel terminal connections.

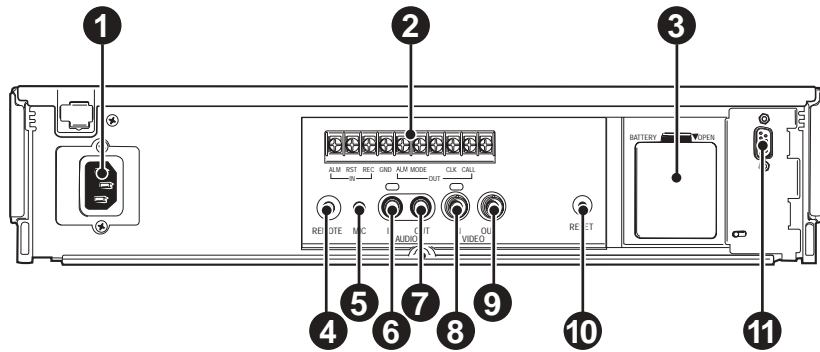

00442

Figure 11. Rear Panel

- 1. AC power socket**
The power cord plugs into this socket. Insert the cord firmly.
- 2. Terminals**
 - Input Terminals
 - ALM (alarm) IN**
Use for alarm recording. Connect the alarm sensor here.
 - RST (reset) IN**
Connect the alarm reset switch here to stop alarm recording when ALARM REC DURATION in the Recording Set Up menu is set to MAN1. You can also use this terminal to set the on-screen clock when set to any mode other than MAN1.
 - REC (recording) IN**
Use to start and stop recording or for series recording (refer to the *Series Recording* section).
 - GND (ground)
Connect the ground lead here when a lead connected to other terminals requires a ground.
 - Output Terminals
 - ALM (alarm) OUT**
Use to indicate to an external device that an alarm is being recorded.
 - MODE OUT**
Use to indicate the VCR's mode of operation. When MODE OUT in the Rear Terminal menu is set to CLOCK ADJ, the clocks of all connected VCRs can be adjusted.
 - CLK (clock) OUT**
Use to control an external camera switcher, such as the MX4000 Series Genex Multiplexer.
 - CALL OUT**
Use to indicate when the tape finishes recording or that there was a problem during recording.
- 3. Battery box**
The battery is stored here. (**NOTE:** This is a special battery. Consult your dealer to replace it.)
- 4. REMOTE jack**
Jack for connecting a remote control unit.

5. **MIC jack**
Jack for connecting a microphone rated at 600 ohms impedance.
6. **AUDIO IN connector**
Audio input connector (RCA pin).
7. **AUDIO OUT connector**
Audio output connector (RCA pin).
8. **VIDEO IN connector**
Input connector for video signal (BNC connector). Connect cameras here.
9. **VIDEO OUT connector**
Output connector for video signal (BNC connector). Connect a monitor here.
10. **RESET button**
Press to erase the date, present time, alarm recording list, power loss list, and the number of tape uses; and reset them to their default values. Power to the VCR is cut off while the button is pressed. If there is a tape in the VCR and the button is released, the power indicator lights and the tape fast forwards for a few seconds. The VCR then turns off.
11. **RS-232 terminal (DB9)**
Input terminal for connecting a PC using an RS-232C crossed cable.

ADJUSTING THE CLOCK AND USING THE JOG AND SHUTTLE CONTROLS

JOG AND SHUTTLE CONTROLS

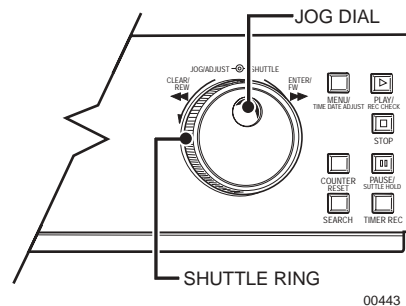

Figure 12. JOG Dial and SHUTTLE Ring

USING THE JOG DIAL

- Turn by using your finger on the indent.
- Turning the JOG dial right advances you through the options while turning left reverses direction.
- When the option is not flashing, turn right to move the cursor downward, turn left to move upward.

USING THE SHUTTLE RING

- The SHUTTLE ring automatically centers itself if you turn it fully right/left and release it.
- Some menus move down to the next layer when you turn the SHUTTLE ring right. Turning it left returns to the previous layer.

ADJUSTING THE CLOCK

You can adjust the VCR's clock on the front panel even when the VCR is turned off. (You can also enter time and date information through the First Time Set Up menu.) This function lets you enter the order of the time, month, day, and year. The hour time is entered twice due to daylight savings time.

To adjust the clock:

1. When the VCR and peripheral devices are turned off, press the MENU button for more than three seconds. The hour digits on the fluorescent display's clock start flashing.
2. Turn the JOG dial to set the hour digits. (If the flashing item is the same as the current time, turn the SHUTTLE ring without turning the JOG dial.)
3. Turn the SHUTTLE ring right to make the 10-minute digit flash, and then turn the JOG dial to adjust.
4. Turn the SHUTTLE ring right to make the 1-minute digit flash, and then turn the JOG dial to adjust. (If you want to finish the clock adjustment now, press the MENU button for more than three seconds.)
5. Turn the SHUTTLE ring right to make the month digits flash, and then turn the JOG dial to adjust. The month indicator (M) lights.
6. Turn the SHUTTLE ring right to make the day digits flash, and then turn the JOG dial to adjust. The day indicator (D) lights.
7. Turn the SHUTTLE ring right to make the year digits flash, and then turn the JOG dial to adjust.
8. Turn the SHUTTLE ring right. The VCR's clock is now set.
9. Repeat steps 1 and 2, and then turn the SHUTTLE ring left to exit after the hour digits are entered the second time (for daylight savings time).

ADJUSTING TO THE EXACT SECOND

Set the clock as described previously, but set the minutes to one minute ahead of the time you are using as a reference. After step 7, turn the SHUTTLE ring right when the desired time reaches 00 seconds of the minute you have chosen.

PROGRAMMING

GENERAL PROGRAMMING INSTRUCTIONS

The following is a universal procedure that shows how programming is done on the VCR. Use the JOG dial to select items, turn the SHUTTLE ring to the right to enter, and turn the SHUTTLE ring to the left to exit.

1. Press the MENU button. The Main menu appears.
2. Turn the JOG dial to select the desired item.
 - Turn right to move the cursor downward.
 - Turn left to move the cursor upward.
3. Turn the SHUTTLE ring right. The desired item is selected and the menu appears.
4. Turn the JOG dial left or right to select an item.
5. Turn the SHUTTLE ring right. The item flashes.
6. Turn the JOG dial left or right to change the setting.
7. Turn the SHUTTLE ring right to enter.
8. Press the MENU button. The day and time display appears.

LANGUAGE SELECTION MENU

The Language menu appears on the screen:

- When you press the MENU button when the VCR is turned on the first time after it is purchased
- When you press the RESET button during use

Remember: After the first time, the only way to access the Language menu is to press the RESET button on the rear panel with a pointed object. Doing so will erase your custom programming and return the unit to factory default settings. Then follow steps 1-4 below.

The menu offers three languages: English (default), French (Français), Spanish (Español). To set the language:

1. Press the MENU button. The Language menu appears.
2. Turn the JOG dial to select the desired language.
3. Turn the SHUTTLE ring right. The Main menu appears in the selected language.
4. Press the MENU button to exit.

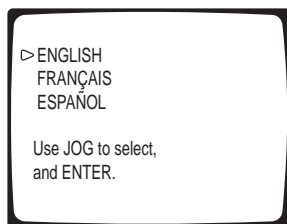

00444

Figure 13. Language Menu

QUICK GUIDE TO THE MENU STRUCTURE

The VCR's operating parameters are set through various on-screen menus. Program your choices on the menus according to the instructions on the following pages.

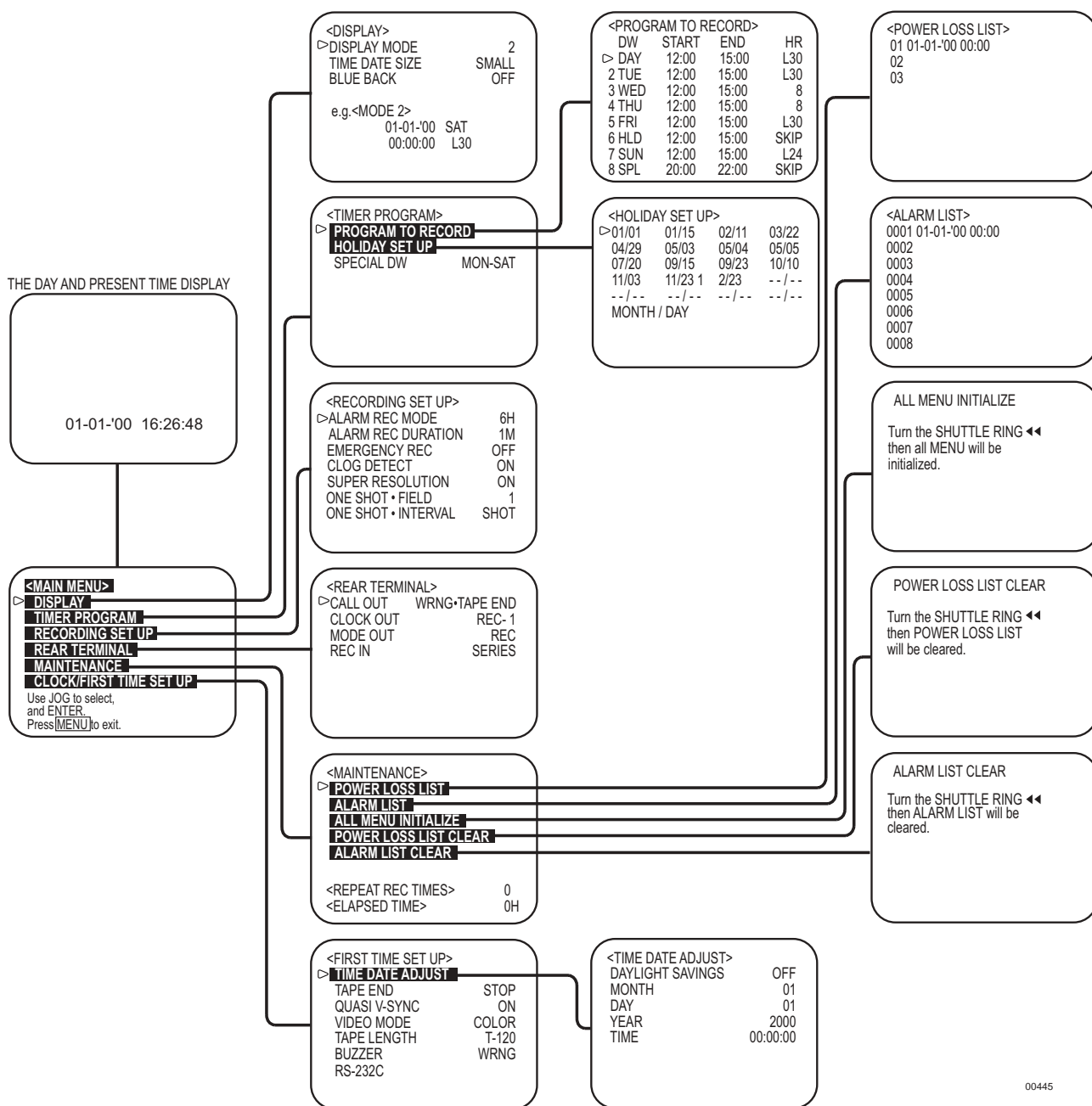

00445

Figure 14. Menu Tree

MAIN MENU

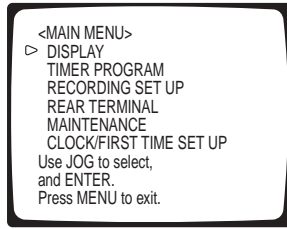

00446

Figure 15. Main Menu

The contents of the Main menu are as follows. Access it by pressing the MENU button.

- **DISPLAY**
Sets the format to display the time and date on the monitor.
- **TIMER PROGRAM**
Sets the timed recordings.
- **RECORDING SET UP**
Sets the alarm recording mode, alarm recording duration, emergency recording, etc.
- **REAR TERMINAL**
Sets the number of frames or fields to record for CLK OUT, output signal of the CALL OUT terminal, the MODE OUT terminal, etc.
- **MAINTENANCE**
Displays the power loss list, alarm list, etc. Also, initializes all menu settings. Clears the power loss list and alarm list.
- **CLOCK/FIRST TIME SET UP**
Sets the time and date, quasi v-sync, VCR operation when the end of the tape is reached, etc.

DISPLAY MENU

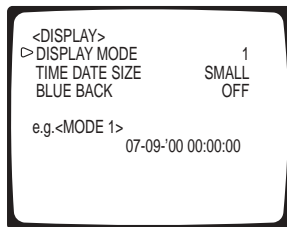

00447

Figure 16. Display Menu

DISPLAY MODE

This is where you set the display mode. (Set the current time and date in the Clock/First Time Set Up menu. Refer to the *Clock/First Time Set Up Menu* section.)

DISPLAY MODE 1 Displays date (month, day, year), time (hour, minute, second), and alarm recording counter.

DISPLAY MODE 2 Displays date, day of the week (SUN, etc.), alarm recording counter, time, and recording mode.

DISPLAY MODE 3 Displays nothing until alarm recording starts—then date, day of the week, alarm recording counter, time, and recording mode are displayed.

DISPLAY MODE 4 Displays nothing on the monitor, even during alarm recording.

TIME/DATE SIZE

This is where you set the size of the letters in the time and date display.

SMALL The letters become small.

LARGE The letters become large.

BLUE BACK

This is where you set the background color.

ON The blue-colored screen overlays the recorded picture when the menu is displayed on the monitor.

When the setting is ON and the video signal is not input, the background color is blue. The warning “NO SIGNAL” flashes on the screen, and “noSlg” flashes on the fluorescent display.

OFF The recorded picture is overlaid with the menu display.

When the setting is OFF and the video signal is not input, the background is blue when the menu is displayed on the monitor.

TIMER PROGRAM

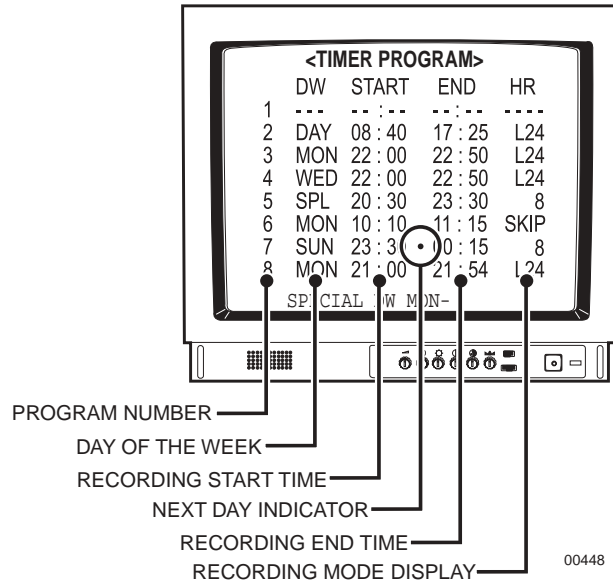

Figure 17. Timer Program Illustration

This is where you set the program number, day of the week, starting and ending times, and the recording mode. (Refer to the *Timer Recording* section for more detailed information and procedures.)

(program number) This number identifies the program (eight maximum). If the recording times of two programs overlap, the higher program number has priority.

DW Day of the week. DAY is used to record at the same time every day. SPL (special) uses the start/end days selected with SPECIAL DW at the bottom of the screen. HLD is used to control recording on holidays (20 maximum).

START/END The VCR uses a 24-hour display for starting and ending recording times. 00:00 indicates midnight, 12:00 is noon, and 15:00 is 3 p.m. An indicator between the START and END columns shows that recording continues to the following day.

HR This is the recording mode. SKIP indicates that timer recording is not performed during the set period. Recording mode varies by the TAPE LENGTH set in the First Time Set Up menu.

RECORDING SET UP MENU

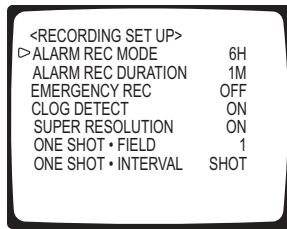

00449

Figure 18. Recording Set Up Menu

Refer to the *Programming for Alarm Recording* section for programming instructions for the following fields.

ALARM REC MODE

Sets the alarm recording mode.

- If TAPE LENGTH in the First Time Set Up menu is set to T-120, the display switches in the following order when you turn the JOG dial: 6H, L18H, L30H, 6H.
- If set to T-160, the display switches in the following order: 8H, L24H, L40H, 8H.

ALARM REC DURATION

Sets the length of the alarm recording period. When you turn the JOG dial, the displays switches in the following order: 1M (minute), 2M, 5M, 10M, MAN1, MAN2, 15S (second), 30S, 45S, 1M.

EMERGENCY REC

Sets the emergency recording mode, as follows:

- ON – Starts alarm recording when the alarm signal is received (ALM IN terminal grounded), not only during recording but also when the power is off, when the tape is stopped, or when the VCR is in standby mode for timer recording.
- OFF – Starts alarm recording when the alarm signal is received (ALM IN terminal grounded) during recording.

CLOG DETECT

Sets clog detection mode, as follows:

- ON – The VCR automatically removes particles that may accumulate on the heads during recording at modes 102H through 224H (except for 128H) or 0H. If they cannot be entirely removed, the warning “CLog” flashes on the fluorescent display.
- OFF – The VCR does not detect a clogged head.

SUPER RESOLUTION

Sets super resolution mode, as follows:

- ON – Recording and playback happen at over 400 lines of resolution.
- OFF – Recording and playback happen at VHS mode.

ONE SHOT•FIELD

Sets the number of recorded fields in one-shot recording mode. When you turn the JOG dial, the display switches in the following order: 1, 2, 3, 4, 5, 10, 20, 30, 1.

ONE SHOT•INTERVAL

Sets the time interval in one-shot recording mode. When you turn the JOG dial, the display switches in the following order: SHOT, 10S (second), 15S, 30S, 45S, 1M (minute), 2M, 3M, SHOT.

REAR TERMINAL MENU

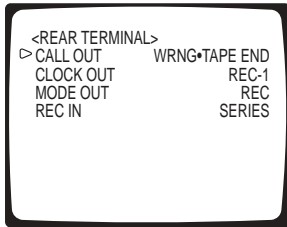

Figure 19. Rear Terminal Menu

Table B. Call Out/Tape End

CALL OUT setting		TAPE END setting		
		WRNG•TAPE END	WRNG•REMAIN	WRNG
STOP		Outputs a call signal at the end of the tape.	Outputs a low active signal three minutes before the tape ends.	When a malfunction occurs in the VCR during recording, a call signal is output.
REWIND		Outputs a call signal at the end of the tape for two seconds.	Same as above	Same as above
REPEAT		Same as above	Same as above	Same as above
ALARM •PROT	When there are alarm recordings during recording	Outputs a call signal at the end of the tape.	Same as above	Same as above
	When there are no alarm recordings during recording	Outputs a call signal at the end of the tape for two seconds. Tape rewinds and recording continues.	Same as above	Same as above

CALL OUT

Sets the call signal output at the end of the tape. Turns on or off the signal coming from the CALL terminal when the end of the tape is reached during recording. If a problem occurs during recording, a call signal is output from the CALL terminal on the rear panel regardless of the CALL OUT setting.

- WRNG•TAPE END – The VCR outputs a call signal at the end of the tape when recording or when a malfunction occurs when recording. What the VCR does when the tape ends depends on the setting for TAPE END in the First Time Set Up menu.
- WRNG•REMAIN – The VCR outputs a call signal when the tape has about nine minutes left (in 6H mode) during recording or when a malfunction occurs during recording.
- WRNG – The VCR outputs a call signal only when a malfunction occurs during recording.

CLOCK OUT

Sets, at the CLOCK OUT terminal, the number of frames or fields being recorded (depending on the recording mode).

1. First, set the recording mode for the CLOCK OUT pulse output in the Rear Terminal menu.
 - REC – When recording in any mode
 - T/L REC - When recording in time-lapse mode (L18H – 224H or 0H)
2. Second, select the frequency interval by turning the JOG dial, switching the display in the following order: 1, 2, 3, 4, 5, 10, 15, 20, 25, 30, 50, 60, F (field), 1. The numbers from 1 to 60 indicate the number of frames at 6H recording mode and the number of fields at time-lapse recording modes. (One frame consists of two fields.) One field is selected when set to F (field).

MODE OUT

Sets the state in which the signal output at the MODE OUT terminal is switched to active. When you turn the JOG dial, the display switches in the following order, and under the following circumstances:

- REC – During recording
- PLAY – During playback
- POWER – While the VCR is turned on
- TAPE IN – When you insert a tape in the VCR
- TAPE REMAIN – When the tape has about nine minutes left (at 6H mode)
- CLOCK ADJ – When the clock indicates 00:00 (minutes:seconds), output the signal for one second only

REC IN

Sets the REC IN terminal's operating mode.

- SERIES – Recording starts when the REC IN terminal is grounded.
- REC-START/STOP – Recording continues while the REC IN terminal is grounded. Recording may not start if the input period is short.
- SYNC REC – Video signal from the multiple of three or five (depending on recording mode) cameras can be recorded separately by connecting a switcher.

MAINTENANCE MENU

Refer to the Maintenance section for instructions and procedures.

FIRST TIME SET UP MENU

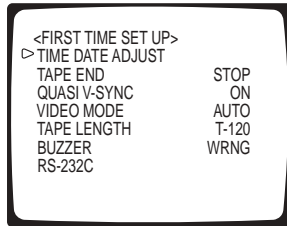

00451

Figure 20. First Time Set Up Menu

NOTE: Quasi v-sync must be set OFF for some multiplexers to work properly. With the Pelco MX4000 Series Genex Multiplexer, setting quasi v-sync on or off has no apparent effect on playback.

NOTE: To stop the buzzer, press the MENU button once. If the Main menu appears, press MENU again to exit the menu. When the VCR is locked, press the LOCK button to unlock the VCR, then the buzzer stops.

TIME DATE ADJUST

Sets the time, date, and daylight savings time settings. Refer to the *Set the Day and Time* section for the procedure.

TAPE END

Sets the VCR's state of operation when the tape runs out during recording, as follows:

- STOP – The tape stops. “End” appears on the fluorescent display and “TAPE END” on the monitor. When CALL OUT is set to WRNG•TAPE END, a call signal is output from the CALL OUT terminal.
- REWIND – Rewinds the tape to the beginning and stops (except during timer recording). When CALL OUT is set to WRNG•TAPE END and a tape reaches its end, a call signal is output for two seconds from the CALL OUT terminal.
- REPEAT – Rewinds the tape to the beginning and resumes the recording. When CALL OUT is set to WRNG•TAPE END and a tape reaches its end, a call signal is output for two seconds from the CALL OUT terminal.
- ALARM•PROT – (Alarm Protection) If alarm recordings are on the tape and the tape stops, “End” appears on the fluorescent display and “TAPE END” on the monitor. When CALL OUT is set to WRNG•TAPE END, a call signal is output from the CALL OUT terminal. If there are no alarm recordings, the tape rewinds and recording continues.

QUASI V-SYNC

Sets quasi v-sync on or off.

- ON – Quasi v-sync signal is inserted on the video output signal when in the special playback modes (still, slow motion, reverse, fast playback, and speed search) and during playback in modes L18H through 224H and 0H.
- OFF – Quasi v-sync signal is not inserted.

VIDEO MODE

Sets the playback and recording color mode.

- AUTO – The VCR automatically switches the circuits according to the type of input/playback video signal: color or black and white.
- B/W – Select for recording or playback in black and white.

TAPE LENGTH

Sets the tape length.

- T-120 – Select when using T-120 tape.
- T-160 – Select when using T-160 tape.

BUZZER

Sets a buzzer to sound a warning.

- WRNG – The buzzer sounds when the VCR malfunctions.
- WRNG•TAPE END – The buzzer sounds when the VCR malfunctions or the tape reaches its end.
- WRNG•REMAIN – The buzzer sounds when the VCR malfunctions or the tape has about nine minutes left (in 6H mode).
- OFF – The buzzer does not sound.

RS-232C

Accesses the RS-232C menu. Refer to the *RS-232C Menu* section for field definitions.

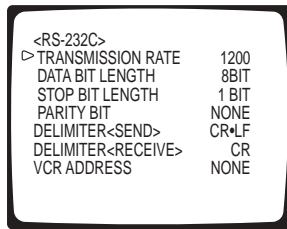

00452

Figure 21. RS-232C Menu

RS-232C MENU

The RS-232C menu is where you set parameters for controlling the VCR with a PC.

TRANSMISSION RATE	Sets the transmission rate. Turn the JOG dial to switch the display in the following order: 1200 (bps), 2400, 4800, 9600, 1200.
DATA BIT LENGTH	Sets the data bit length. Turn the JOG dial to switch the display in the following order: 8BIT, 7BIT, 8BIT.
STOP BIT LENGTH	Sets the stop bit length. Turn the JOG dial to switch the display in the following order: 1BIT, 2BIT, 1BIT.
PARITY BIT	Sets the parity bit. Turn the JOG dial to switch the display in the following order: NONE, ODD, EVEN, NONE.
DELIMITER<SEND>	Sets the character to mark the end of a status or error code. Turn the JOG dial to switch the display in the following order: CR•LF (carriage return code and line feed code), CR, CR•LF.
DELIMITER<RECEIVE>	Sets the character to mark the end of a command. Turn the JOG dial to switch the display in the following order: CR•LF (carriage return code and line feed code), CR, CR•LF.
VCR ADDRESS	Sets the ID of the VCR. Turn the JOG dial to switch the display in the following order: NONE, VCR01, VCR02 ... VCR254, VCR255.

ADDITIONAL MATERIAL

DAY AND TIME DISPLAY MODES

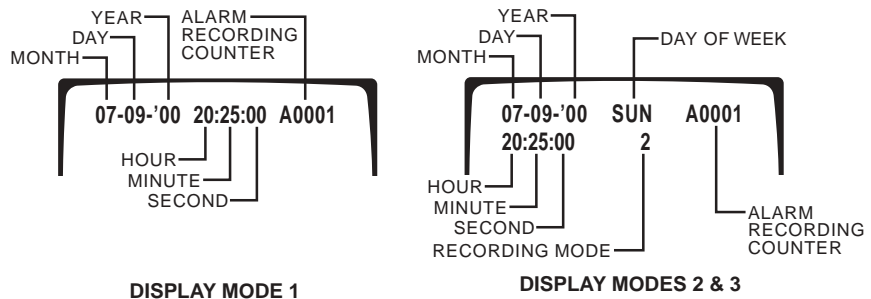

00453

Display Mode 1

- Month-Day-Year
- Hour:Minute:Second
A 24-hour display is used: 00:00 indicates midnight; 12:00 is noon; and 15:00 is 3 p.m.
- Alarm recording counter
An alarm recording counter is displayed during alarm recording.

Display Mode 2

- Month-Day-Year
- Day of the week
The day of the week is set automatically.
- Alarm recording counter
- Hour:Minute:Second
- Recording mode

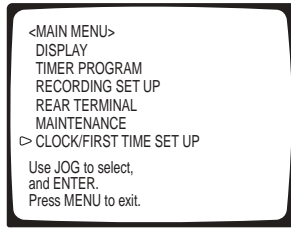

00454

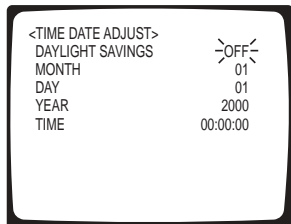

00457

NOTE: If power goes out while daylight savings time is selected, the power failure mark "X" replaces the daylight savings time symbol. When the power failure mark "X" disappears, the daylight savings time symbol reappears.

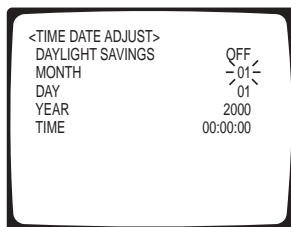

00458

NOTE: The POWER button will not operate if any menu display is flashing.

SET THE DAY AND TIME

Keep the following in mind:

- You must set the day and time before performing timer programming.
- The year 2000 is shown as 00.
- The clock is in 24-hour format.
- The alarm recording counter appears only during alarm recording.

Do the following to set the day and time:

1. Press the MENU button to display the Main menu on the monitor.
2. Turn the JOG dial to select CLOCK/FIRST TIME SET UP, and then turn the SHUTTLE ring right. The First Time Set Up menu appears.



00455



00456

3. Turn the JOG dial to select TIME DATE ADJUST, and then turn the SHUTTLE ring right. The Time Date Adjust menu appears.
4. Turn the JOG dial to set DAYLIGHT SAVINGS, and then turn the SHUTTLE ring right. The daylight savings item flashes.

- When set to ON, the clock advances one hour.
- When set to AUTO, the clock advances one hour from the first Sunday in April (at 2 a.m.) to the last Sunday in October (at 3 a.m.). **Remember:** Programmed recordings starting or ending in the daylight savings time changeover period may not be recorded correctly.
- When set to ON or AUTO and the clock advances, the daylight savings time symbol (☀) is displayed next to the present time display. The daylight savings time indicator (■) is illuminated on the fluorescent display.

Daylight savings time may vary from the one above depending on your region or the year. In this case, set DAYLIGHT SAVINGS to ON or OFF manually.

When DAYLIGHT SAVINGS is set to ON or OFF and there is no tape in the VCR, you can toggle DAYLIGHT SAVINGS to ON and OFF on the VCR's front panel by simultaneously pressing the STOP and EJECT buttons.

5. Turn the JOG dial to set the month, and then turn the SHUTTLE ring right.
6. Set DAY, YEAR, and TIME the same way. Year digits can be set from 97 (for year 1997) to 27 (for 2027).

Do the following if you want to set the time to the exact second. Set the minute digits one minute ahead of the time you are using as a reference. The digit on the right will flash and the seconds digits stay at 00. Turn the SHUTTLE ring right when the time reaches 00 seconds of the time you set. The time will begin counting from 00. Turn the JOG dial to set the day, and then turn the SHUTTLE ring right.

7. Turn the SHUTTLE ring right while the 1-minute digit of TIME is flashing. Programming is now complete. The First Time Set Up menu appears.
8. Press the MENU button. The day and time display appears on the screen.

LOADING, UNLOADING, PROTECTING THE TAPE CASSETTE

You can load video cassette tapes into your VCR as long as it is plugged into a power source. Loading a cassette automatically turns the VCR on even if its power switch is turned off. Use only video cassette tapes marked VHS or SVHS.

We recommend using high grade (HG) tape. (Standard grade tape can be used, but is not recommended.) Use high grade VHS tape for super resolution recording. We also recommend using T-120 or T-160 tape; nothing longer.

LOADING

1. Prepare to insert the cassette into the cassette slot by holding it so the long narrow edge with the contents label faces you. The hinged narrow edge should face the VCR. The clear plastic window showing the tape should face up.
2. Line up the cassette squarely with the cassette slot and gently push the cassette in until the VCR pulls it in. The cassette status indicator on the fluorescent display lights when the cassette is inserted.

The VCR's protection circuit will eject improperly loaded cassettes. If the VCR ejects the cassette you are trying to load, remove it and check that the contents label is facing you and the clear plastic window showing the tape faces up. Wait a few seconds and try again.

Also, you cannot load cassette while all the VCR's buttons are locked and the lock all indicator (LOCK A) is lit.

3. The VCR turns on automatically. If the erasure prevention tab on the cassette has been removed, the VCR automatically plays back the tape.

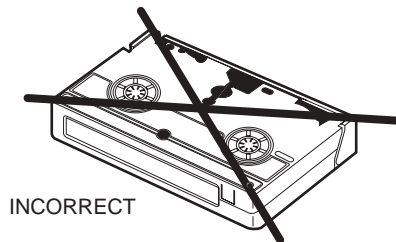
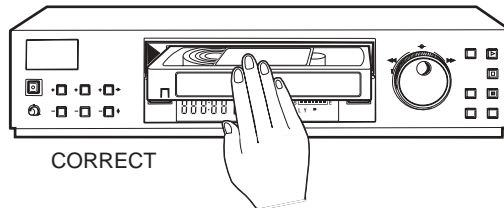

00459

UNLOADING

1. Press the EJECT button on the front of the VCR.

Even in standby mode the VCR will eject a video cassette. When you press EJECT, the VCR automatically turns on, ejects the tape, and turns off.

You cannot eject a tape while recording without first pressing the STOP button, or while all the VCR's buttons are locked.

2. Remove the cassette.

PREVENTING ACCIDENTAL ERASURE

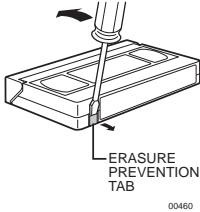

Video cassettes come with an erasure prevention tab. Removing it stops the tape's contents from being erased or recorded over. The VCR automatically ejects a cassette if you try to record over it with the erasure prevention tab removed.

DAMAGED CASSETTE TAPE

We recommend taking any torn or broken cassette tape requiring repair only to professionals who specialize in such procedures. The adhesives on many common types of tape could damage the heads on the VCR.

WHEN TO REPLACE A TAPE

We recommend you replace the tape cassette with a new one according to the mode in which it is used. Refer to Table C.

Table C. Tape Replacement by Use

T-120		T-160	
Recording Time Mode	Number of Tape Uses	Recording Time Mode	Number of Tape Uses
6H	100	8H	50
L18H	60	L24H	30
L30H	25	L40H	10
48H	20	64H	5
72H	15	96H	3
120H	15	128H	3
168H	10	160H	2
0H	8	224H	1
	1	0H	1

RECORDING

MANUAL RECORDING

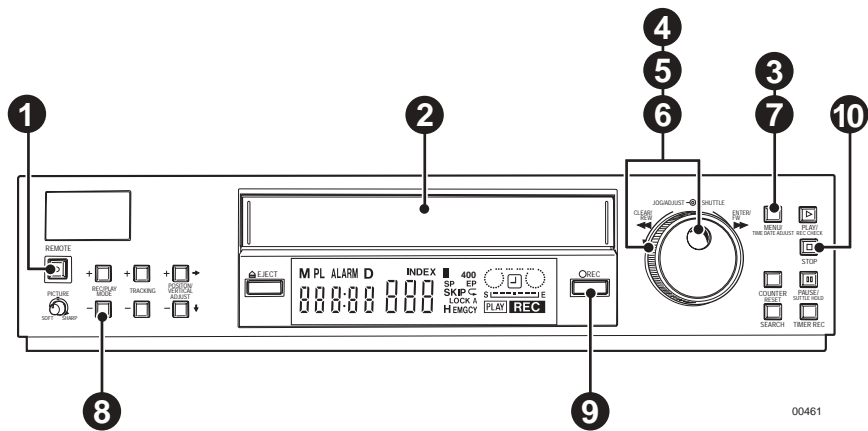

NOTE: Perform steps 3-7 to activate super resolution recording mode. Otherwise, skip to step 8.

1. Turn on the VCR and peripheral devices.
2. Load a cassette with the erasure prevention tab intact.
3. Press the MENU button. The Main menu appears.
4. Turn the JOG dial to select RECORDING SET UP, and then turn the SHUTTLE ring right. The Recording Set Up menu appears.
5. Turn the JOG dial to select SUPER RESOLUTION, and then turn the SHUTTLE ring right.
6. Turn the JOG dial to select ON, and then turn the SHUTTLE ring right.
7. Press the MENU button. The day and time display appears on the screen.
8. Press the REC/PLAY MODE button to select the desired recording mode. Refer to Table D for recording and playback times.
9. Press the REC button to begin recording.
10. Press the STOP button to stop recording.

Keep the following in mind:

- Press the PAUSE button to momentarily stop recording. Press again to resume recording.
- To protect the tape, pause mode is automatically cancelled after about five minutes.
- If the tape you insert in the VCR has the erase prevention tab removed, the VCR will eject it if you try recording on it.
- The REC button will not work unless the VCR is in stop or pause mode.
- A tape recorded on this VCR may or may not play back correctly on another VCR.

RECORDING MODE

Pressing the REC/PLAY MODE button switches the recording mode in the following order:

- For T-120 tape: 6H, L18H, L30H, 48H, 72H, 96H, 120H, 168H
- For T-160 tape: 8H, L24H, L40H, 64H, 96H, 128H, 160H, 224H

Table D. Recording/Playback Times

Recording Mode	T-120	T-160
2H*	2:00	2:40
6H	6:00	---
8H	---	8:00
L18H	18:00	---
L24H	---	24:00
L30H	30:00	---
L40H	---	40:00
48H	54:00	---
64H	---	72:00
72H	78:00	---
96H	102:00	104:00
120H	162:00	---
128H	---	136:00
160H	---	168:00
168H	174:00	---
224H	---	232:00

* Playback only

RECORDING CHECK FUNCTION

When the VCR is recording, press the REC CHECK button for more than 1.5 seconds and then release. The tape rewinds a little and then the VCR plays back the recording just made. When the tape reaches the spot where you pressed REC CHECK, the VCR starts recording again.

AUDIO RECORDING/PLAYBACK

Audio will not be recorded if cables are not connected to the AUDIO IN connector or the microphone is not connected to the MIC IN jack.

The 2H (playback only), 6H, and 8H modes and L18H, L24H, L30H, and L40H modes are for audio recording and playback on the linear track. Normal sound is played back only when a tape recorded in these modes is played back in its respective mode.

The lengthier the recording mode, the poorer the sound quality. In L30H and L40H modes, sound quality is such that speech can be heard.

REPEAT RECORDING

With this function, when the tape reaches its end during recording, the VCR rewinds the tape and starts recording again. Table E shows what happens automatically when the tape ends during recording.

1. Press the MENU button. The Main menu appears.
2. Turn the JOG dial to select CLOCK/FIRST TIME SET UP, and then turn the SHUTTLE ring right. The First Time Set Up menu appears.
3. Turn the JOG dial to select TAPE END, and then turn the SHUTTLE ring right.
4. Turn the JOG dial to select REPEAT or ALARM•PROT, and then turn the SHUTTLE ring right. Refer to Table E. The repeat indicator on the fluorescent display lights.
5. Press the MENU button. The day and time display appears on the screen.

Table E. Action When Tape End Is Reached by Setting

	STOP	REWIND	REPEAT	ALARM•PROT
When there are alarm recordings on the tape	The tape stops.	The tape automatically rewinds to the beginning (except in timer recording) and stops.	The tape automatically rewinds to the beginning and recording resumes (over the existing alarms).	The tape stops.*
When there is NO alarm recording on the tape	Same as above	Same as above	Same as above	The tape automatically rewinds to the beginning and recording resumes.

* To repeat recording on the same tape in ALARM•PROT mode, eject the tape once and reinsert.

Recommended Number of Tape Uses

Video tape wears during use. Use a new cassette according to Table C.

SERIES RECORDING

You can do series recording by connecting two or more TLR3168 VCRs together. Refer to Figure 4 for the physical connection.

When the first VCR's tape reaches its end or a malfunction occurs, the second VCR automatically begins recording.

Series recording cannot be used with timer or emergency recording.

When recording in series, set CALL OUT in the Rear Terminal menu to a mode other than WRNG.

There are two types of series recording. Choose either Series Recording 1 or Series Recording 2.

Series Recording 1

When the first VCR's tape reaches its end during recording or a malfunction occurs, the second VCR automatically begins recording.

1. Press the MENU button. The Main menu appears.
2. Turn the JOG dial to select REAR TERMINAL, and then turn the SHUTTLE ring right. The Rear Terminal menu appears.
3. (Perform this step and step 4 on the **first VCR only**.) When the cursor is next to CALL OUT, turn the SHUTTLE ring right.
4. Turn the JOG dial to select WRNG•TAPE END, and then turn the SHUTTLE ring right.
5. (Perform this step and step 6 on the **second VCR only**.) Turn the JOG dial to select REC IN, and then turn the SHUTTLE ring right.
6. Turn the JOG dial to select SERIES, and then turn the SHUTTLE ring right.
7. Press the MENU button. The day and time display appears.

Series Recording 2

When the first VCR's tape reaches its end, the second VCR automatically begins recording. When the second VCR's tape reaches its end, the first VCR starts recording again. The two keep recording one after the other. Set up **both** VCR as follows:

1. Perform steps 1 through 6 in the Series Recording section above. Steps 3 through 6 must be done for **both the first and second VCR**.
2. Turn the SHUTTLE ring left. The Main menu appears.
3. Turn the JOG dial to select CLOCK/FIRST TIME SET UP, and then turn the SHUTTLE ring right. The First Time Set Up menu appears.
4. Turn the JOG dial to select TAPE END, and then turn the SHUTTLE ring right.
5. Turn the JOG dial to select REWIND, and then turn the SHUTTLE ring right.
6. Press the MENU button. The day and time display appears.

REMOTE RECORDING

This function lets you control the start and end of recording from a remote location. The VCR starts recording when the REC IN terminal is grounded. Refer to Figure 5 for the remote recording connection.

An index signal is not recorded during remote recording. Series and timer recording cannot be used simultaneously with remote recording.

1. Press the MENU button. The Main menu appears.
2. Turn the JOG dial to select REAR TERMINAL, and then turn the SHUTTLE ring right. The Rear Terminal menu appears.
3. Set REC IN to REC-START/STOP.
4. Press the MENU button. The day and time display appears on screen.

ONE-SHOT/INTERVAL RECORDING

One-shot recording lets you control the number of fields to be recorded when the REC button is pressed or the REC IN terminal is grounded. Interval recording is made at the selected number of fields and at the selected interval.

1. Press the REC/PLAY MODE button on the front panel to set the recording mode to 0H.
2. Press the MENU button. The Main menu appears.
3. Turn the JOG dial to select RECORDING SET UP, and then turn the SHUTTLE ring right. The Recording Set Up menu appears.
4. Turn the JOG dial to select ONE SHOT•INTERVAL, and then turn the SHUTTLE ring right.
5. Turn the JOG dial to select the number of fields to record, and then turn the SHUTTLE ring right.
6. Turn the JOG dial to select ONE SHOT•INTERVAL, and then turn the SHUTTLE ring right.
7. Do one of the following:
 - If setting up one-shot recording:
Turn the JOG dial to select SHOT, and then turn the SHUTTLE ring right.
 - If setting up interval recording:
Turn the JOG dial to select the recording interval, and then turn the SHUTTLE ring right.
8. Press the REC button. One of the following will occur:
 - One-shot recording will be in standby mode.
 - The VCR starts interval recording with the interval time you chose in step 7.
9. To start one-shot recording, press the REC button again or switch the REC IN terminal on the rear panel to the ground.

SYNCHRONOUS RECORDING

Several camera images can be mixed together through a camera switcher and then recorded separately onto several VCRs. To do so, assign a camera to each VCR. The VCR records only the camera assigned to it. This allows recording without gaps.

If you have three VCRs, the video signal from three cameras can be recorded separately by connecting the switcher as shown in Figure 6 and Figure 22.

The recording mode must be set to L18H, L24H, L30H, or L40H. Table A shows the suitable numbers of VCRs and cameras.

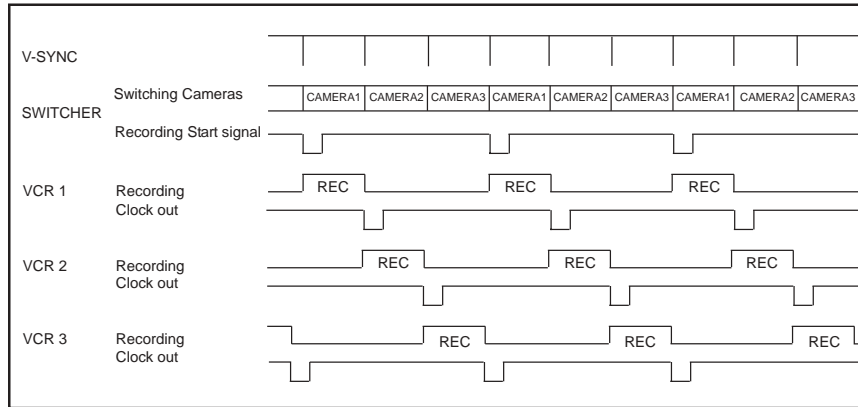

00462

Figure 22. Synchronous Recording Sequence

Table F. Numbers of VCRs and Cameras

Recording Time Mode	Number of VCRs	Number of Cameras
L18H, L24H L30H, L40H	3 5	Multiple of 3 (3, 6, 9, etc.) Multiple of 5 (5, 10, 15, etc.)

The programming procedure is as follows;

1. Press the MENU button. The Main menu appears.
2. Turn the JOG dial to select REAR TERMINAL, and then turn the SHUTTLE ring right. The Rear Terminal menu appears.
3. Turn the JOG dial to select REC IN, and then turn the SHUTTLE ring right.
4. (Perform steps 4-7 on **VCR1 only**.) Do one of the following:
 - Turn the JOG dial to select SERIES or REC START/STOP, and then turn the SHUTTLE ring right.
 - If the recording start signal is available on the switcher, select SYNC REC.
5. Turn the JOG dial to select CLOCK OUT, and then turn the SHUTTLE ring right.
6. Turn the JOG dial to select T/L-REC, and then turn the SHUTTLE ring right.
7. Turn the JOG dial to select F, and then turn the SHUTTLE ring right.
8. (Perform step 8 on all VCRs, **except** VCR1.) Turn the JOG dial to select SYNC REC, and then turn the SHUTTLE ring right.
9. Press the MENU button. The day and time display appears on screen.

TIMER RECORDING

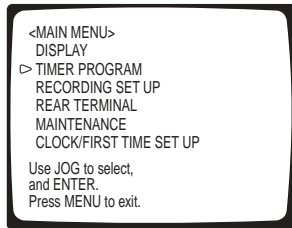

00463



00464

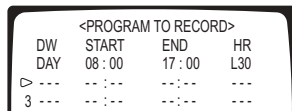

00465

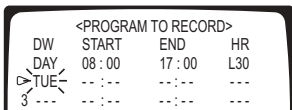

00466

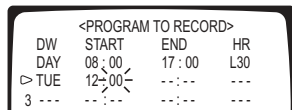

00467

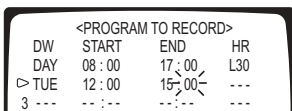

00468

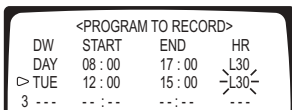

00469

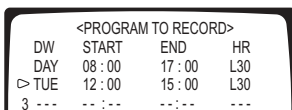

00470

Remember to set the date and time before timer programming.

PROGRAMMING PROCEDURE

(Refer to the *Timer Program* section for information on the columns on the Programming to Record menu.)

1. Press the MENU button. The Main menu appears.
2. TIMER PROGRAM, and then turn the SHUTTLE ring right. The Timer Program menu appears.
3. When the cursor is next to PROGRAM TO RECORD, turn the SHUTTLE ring right. The Program To Record menu appears.
4. Turn the JOG dial to select the program number, and then turn the SHUTTLE ring right.
5. To set the day of the week (DW), turn the JOG dial to select the day, and then turn the SHUTTLE ring right.

- Select DAY to record at the programmed time every day.
- Select HLD to apply HOLIDAY SET UP settings (refer to the *Holiday Set Up* section).
- Select SPL to apply SPECIAL DW settings (refer to the *Special DW Settings* section).

6. To set the START recording time, turn the JOG dial to select the hour digits (24-hour format). Turn the SHUTTLE ring right when done.

Set the 10-minute and 1-minute digit positions in the same way.

7. To set the END recording time, turn the JOG dial to select the hour digits (24-hour format). Turn the SHUTTLE ring right when done.

Set the 10-minute and 1-minute digit positions in the same way.

8. To set the recording mode (HR), turn the JOG dial to select the recording mode. (Timer recording will not be performed if you set it to SKIP.)
9. (Perform this step to record while the REC IN terminal is grounded. If not, skip to step 10.) Press the MENU button. The program you are currently setting is highlighted. Press the MENU button again to cancel.
10. Turn the SHUTTLE ring right when done. If the program has not been set completely, the DW column will keep flashing.

- If the END time is the same or earlier than the START time, the next day indicator (•) is automatically displayed. This indicates the recording will run continuously from the START time on the first day to the END time on the next day.
- Repeat steps 4-9 to set two or more programs at once (you can set up to eight programs).
- To erase a program setting, select the program number to be erased. Turn the SHUTTLE ring right to flash the day of the week, then turn the SHUTTLE ring **left**.

11. Press the MENU button. The day and time display appears on screen.
12. Press the TIMER REC button. The VCR turns off and the timer recording indicator lights on the fluorescent display. (When you press the TIMER REC button during the programmed period, the VCR starts recording immediately.)

HOLIDAY SET UP

Up to 20 days a year can be set as days to perform timer recording. Or you can specify up to 20 days when timer recording will not be performed during the programmed period by setting HR in the Program to Record menu to SKIP.

1. Press the MENU button. The Main menu appears.
2. Turn the JOG dial to select TIMER PROGRAM, and then turn the SHUTTLE ring right. The Timer Program menu appears.
3. Turn the JOG dial to select HOLIDAY SET UP, and then turn the SHUTTLE ring right. The Holiday Set Up menu appears.
4. Turn the JOG dial to move the cursor right to select the month you want, and then turn the SHUTTLE ring right.

To erase the preset month and day, turn the SHUTTLE ring **left** while the month item is flashing.
5. Turn the JOG dial to select the day you want, and then turn the SHUTTLE ring right. Repeat steps 4 and 5 to set two or more days at once.
6. Press the MENU button. The day and time display appears.

SPECIAL DW SETTING

You can set the recording period by specifying the start and end day of the week for timer programming.

1. Press the MENU button. The Main menu appears.
2. Turn the JOG dial to select TIMER PROGRAM, and then turn the SHUTTLE ring right. The Timer Program menu appears.
3. Turn the JOG dial to select SPECIAL DW, and then turn the SHUTTLE ring right.
4. Turn the JOG dial to set the start day, and then turn the SHUTTLE ring right.
5. Turn the JOG dial to set the end day, and then turn the SHUTTLE ring right. The start and end days cannot be set to the same day.
6. Press the MENU button. The day and time display appears.

OVERLAPPING PROGRAMS

When the recording period of two or more programs overlap, the VCR always gives priority to the higher-numbered program.

WHAT IF THE TIMER RECORDING INDICATOR STARTS FLASHING?

Do the following if the timer recording indicator starts flashing:

1. Press the TIMER REC button to turn off the timer recording indicator.
2. The flashing indicator can mean:
 - A tape is not inserted. **Remedy:** Insert a tape.
 - A tape without an erasure prevention tab is inserted. **Remedy:** Insert a tape with an erasure prevention tab.
 - The day and time have not been set. **Remedy:** Set the day and time (refer to the *Adjusting the Clock* or *Set the Day and Time* section).
 - The timer program has not been set. **Remedy:** Confirm the program.
 - A menu item has been set (flashing). **Remedy:** Turn the SHUTTLE ring right to stop the flashing.
3. Press the TIMER REC button to turn on the timer recording indicator.

ALARM RECORDING

When an alarm occurs, the VCR switches to alarm recording.

- Set the alarm recording mode and alarm recording period in the Recording Set Up menu. Refer to the *Recording Set Up Menu* section for field definitions and additional information and the *Programming for Alarm Recording* section for instructions.
- The index signal is recorded automatically when an alarm recording begins (INDEX indicator flashes on the fluorescent display).
- Even if an alarm recording is happening, a new recording starts when the second alarm signal is input. (However, if the interval between two alarm recording start times is too short, the second signal may not be detected during skip or index search. Refer to Table G.)

Table G. Minimum Interval Between Recordings

Alarm Recording Mode	Minimum Interval Between Two Alarm Recording Start Times
6H (8H) L18H (L24H) L30H (L40H)	Approx. 15 seconds Approx. 2 minutes Approx. 2 minutes

- An alarm recording continues until its end during timer recording, even if the timer recording end time is reached.
- An alarm recording is cancelled if the tape reaches its end.

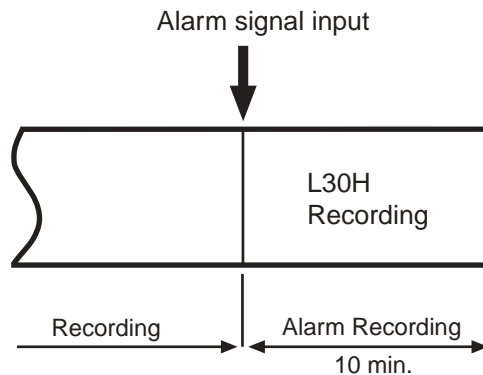

00471

Figure 23. VCR Switches to Alarm Mode

ALARM RECORDING CONNECTION

You can confirm an alarm from a distance by connecting the ALM OUT terminal to an existing alarm system panel or other external device, such as a buzzer. Refer to Figure 3.

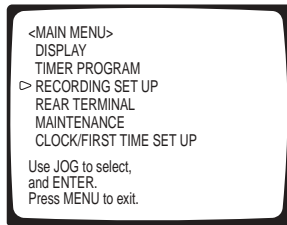

00472

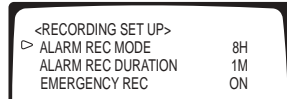

00473

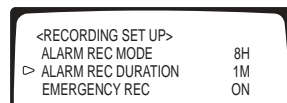

00474

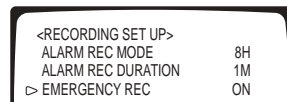

00475

NOTE: If an alarm input is received during alarm recording, a new alarm recording will start with the new input signal.

PROGRAMMING FOR ALARM RECORDING

Alarm recording will continue for the period set in the ALARM REC DURATION field, even if a timer recording has reached its end time.

Alarm recording stops when the end of the tape is reached.

Emergency recording activates alarm recording even if the VCR is off, stopped, or in timer recording or standby modes. The emergency recording indicator (EMGCY) on the fluorescent display lights provided EMERGENCY REC is ON. After an emergency recording, the VCR automatically returns to its original state.

You should set the alarm recording mode in the Recording Set Up menu before using alarm recording.

1. Press the MENU button. The Main menu appears.
2. Turn the JOG dial to select RECORDING SET UP, and then turn the SHUTTLE ring right. The Recording Set Up menu appears.
3. When the cursor is next to ALARM REC MODE, turn the SHUTTLE ring right.
4. Turn the JOG dial to set the alarm recording mode you want, and then turn the SHUTTLE ring right.
5. Turn the JOG dial to select ALARM REC DURATION, and then turn the SHUTTLE ring right.
6. Turn the JOG dial to set the alarm recording duration you want, and then turn the SHUTTLE ring right.
 - When set to MAN1, alarm recording continues until the RST (reset) IN terminal is grounded.
 - When set to MAN2, alarm recording continues while the ALM IN terminal is grounded.
 - You can adjust the internal time clock by applying a signal to the RST IN terminal when ALARM REC DURATION is set to other than MAN1.
7. If you wish to activate emergency recording, turn the JOG dial to select EMERGENCY REC, and then turn the SHUTTLE ring right. Turn the JOG dial to select ON for emergency recording. The emergency recording indicator (EMGCY) lights on the fluorescent display.
8. Press the MENU button. The day and time display appears.

During alarm recording, the alarm recording count is displayed automatically except when Display Mode 4 (display nothing) is selected.

- The alarm recording count display counts up to 9999 alarm recordings and then resets to 0000 and continues counting.
- When initializing the alarm recording list, the alarm recording count display is reset.
- The alarm indicator (ALARM) flashes during alarm recording and stays lit when the alarm recording finishes.
- When alarm recording finishes, the VCR resumes recording in the same mode as before the alarm recording.
- If you are programming on any of the menus and an alarm input signal is received at the ALM IN terminal, alarm recording begins and the menu being programmed disappears from the screen.

RECORDING AFTER A POWER FAILURE

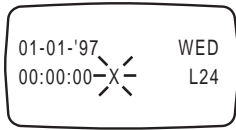

00476

After a power failure during manual, timer, or alarm recording, the VCR turns itself on when the power is restored and begins recording in the same mode as before the failure.

When power is restored, an "X" appears next to the present time on the screen for about a minute. The fluorescent display shows the power loss indicator (PL).

If there is a power failure during playback, the VCR will be in stop mode when power is restored.

Refer to the *Power Loss List* section for more information on viewing and clearing the list.

MAINTENANCE

POWER LOSS LIST

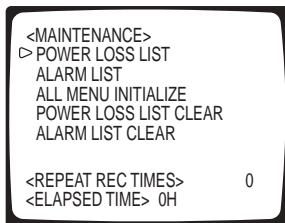

00477

Figure 24. Maintenance Menu

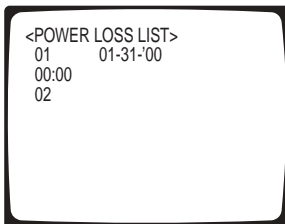

00478

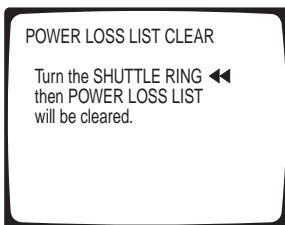

00479

The Power Loss List displays up to three power failure start times. If more occurred, the first and last two start times will be displayed.

VIEWING THE POWER LOSS LIST

1. Press the MENU button. The Main menu appears.
2. Turn the JOG dial to select MAINTENANCE, and then turn the SHUTTLE ring right. The Maintenance menu appears.
3. Turn the JOG dial to select POWER LOSS LIST, and then turn the SHUTTLE ring right. The Power Loss List appears.
4. Press the MENU button. The day and time display appears.

CLEARING THE POWER LOSS LIST

1. Press the MENU button. The Main menu appears.
2. Turn the JOG dial to select MAINTENANCE, and then turn the SHUTTLE ring right. The Maintenance menu appears.
3. Turn the JOG dial to select POWER LOSS LIST CLEAR, and then turn the SHUTTLE ring right.

(If you change your mind at this point and want to exit the menu **without clearing** the list, skip to step 5.)

4. Turn the SHUTTLE ring left to clear the list. The Maintenance menu appears.
5. Press the MENU button.

Once the list is cleared, the power loss list indicator (PL) goes off.

ALARM LIST

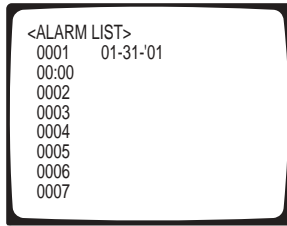

00480

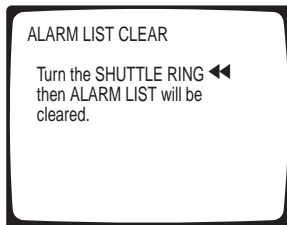

00481

When alarm recordings begin, the start times are stored in memory so you can confirm when they occurred. Up to eight alarm recording start times can be stored in memory. If there are more, the first one and last seven are displayed. A maximum of 9,999 alarm recording start times will be counted.

VIEWING THE ALARM LIST

1. Press the MENU button. The Main menu appears.
2. Turn the JOG dial to select MAINTENANCE, and then turn the SHUTTLE ring right. The Maintenance menu appears.
3. Turn the JOG dial to select ALARM LIST, and then turn the SHUTTLE ring right. The Alarm List appears.
4. Press the MENU button. The day and time display appears.

CLEARING THE ALARM LIST

1. Press the MENU button. The Main menu appears.
2. Turn the JOG dial to select MAINTENANCE, and then turn the SHUTTLE ring right.
3. Turn the JOG dial to select ALARM LIST CLEAR, and then turn the SHUTTLE ring right.

(If you change your mind at this point and want to exit the menu **without clearing** the list, skip to step 5.)

4. Turn the SHUTTLE ring left to clear the list. The Maintenance menu appears.
5. Press the MENU button.

Once the list is cleared, the alarm recording indicator (ALARM) on the fluorescent display goes off.

ALL MENU INITIALIZE (RESET)

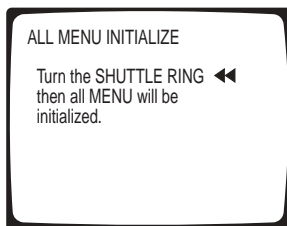

00482

This feature resets all menus (except timer programs) to their initial settings.

1. Press the MENU button. The Main menu appears.
2. Turn the JOG dial to select MAINTENANCE, and then turn the SHUTTLE ring right. The Maintenance menu appears.
3. Turn the JOG dial to select ALL MENU INITIALIZE, and then turn the SHUTTLE ring right. The All Menu Initialize menu appears.

(If you change your mind at this point and want to exit the menu **without resetting** all menus, skip to step 5.)

4. Turn the SHUTTLE ring left. All menus (except Timer Program) return to their original settings.
5. Press the MENU button. The day and time display appears.

ELAPSED TIME AND REPEAT RECORDING TIMES DISPLAY

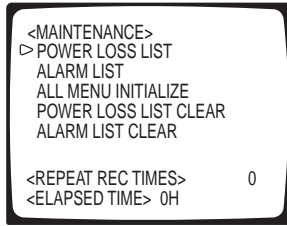

00483

The repeat recording times and elapsed time are shown on the bottom of the Maintenance menu.

ELAPSED TIME

The elapsed time indicates the total time the VCR has been used for recording and playback (up to 89,999 hours). Use the elapsed time as a guide for periodic parts replacement.

REPEAT REC TIMES

- The repeat recording times field displays the number of times a tape has been recorded on when the tape ends during recording (except when TAPE END in the First Time Set Up menu is set to STOP).
- The number of tape uses is kept even if AC power is disconnected, provided the backup battery is fully charged.
- The number of tape uses is reset when a new tape is inserted.
- The number of tape uses shown can be up to 200. "OVER" appears if 200 times is exceeded.

To view:

1. Press the MENU button. The Main menu appears.
2. Turn the JOG dial to select MAINTENANCE, and then turn the SHUTTLE ring right. The Maintenance menu appears. The repeat recording times and elapsed time are shown at the bottom of the screen.
3. Press the MENU button. The day and time display appears.

PLAYBACK

PLAYBACK PROCEDURE

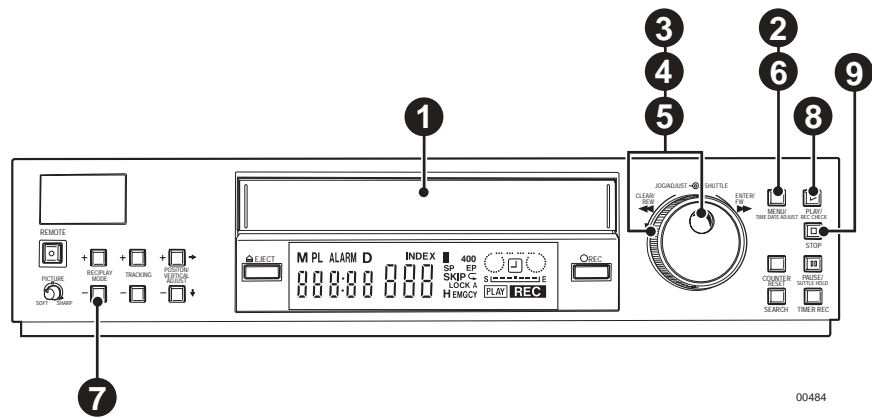

Figure 25. Playback Controls

1. Load a pre-recorded tape. (Turn on the VCR and peripherals if you have not already done so. If the erasure prevention tab has been removed, the VCR automatically begins playback mode.)
2. (Perform steps 2 through 6 if you want to activate super resolution mode; otherwise, skip to step 7.) Press the MENU button. The Main menu appears.
3. Turn the JOG dial to select RECORDING SET UP, and then turn the SHUTTLE ring right. The Recording Set Up menu appears.
4. Turn the JOG dial to select SUPER RESOLUTION, and then turn the SHUTTLE ring right.
5. Turn the JOG dial to select ON, and then turn the SHUTTLE ring right.
6. Press the MENU button. The day and time display appears.
7. Press the REC/PLAY MODE buttons (+ or -) to select the desired playback mode. (Refer to the *Playback Mode* section for more information.)
8. Press PLAY to start playback. (If noise occurs, adjust the tracking. Refer to the *Tracking Adjustment* section.)

When a pre-recorded tape is used for recording, colored noise may appear on the beginning of the playback picture.

9. Press STOP to halt playback.
 - Turn the SHUTTLE ring left to rewind the tape when the VCR is stopped. Press STOP to stop.
 - Turn the SHUTTLE ring right to fast forward the tape when the VCR is stopped. Press STOP to stop.
 - Fast forward/rewind time of a T-120 tape is about two minutes, but can vary according to the type of tape.

PLAYBACK MODE

- Pressing the REC/PLAY MODE button switches playback mode for the T-120 setting in the following order: 6H, L18H, L30H, 48H, 72H, 96H, 120H, 168H, 0H, 6H (for a tape recorded in longer than 6H mode). For the T-160 setting, the order is: 8H, L24H, L40H, 64H, 96H, 128H, 160H, 224, 0H, 8H (for a tape recorded in longer than 8H mode).
- A tape recorded in SP mode using another VCR can only be played back in 2H mode.
- Picture jitter or noise may occur when the tape is played back in L18H, L24H, L30H, or L40H mode (even if the tape was recorded in that mode).

AUDIO PLAYBACK

There is normal sound playback only when a tape recorded in 6H, 8H, L18H, L24H, L30H, or L40H mode is played back in its respective mode.

Table H. Audio Playback and Picture Quality

Playback Mode	2H-8H	L18H-L40H	48H-128H
Audio Playback	Very good	Good	Not available
Picture Quality	Very good	Good	Good

END OF TAPE

When the end of the tape is reached, the following functions are performed automatically during playback or fast forwarding.

Table I. End of Tape Actions

Tape End Selected	REPEAT or ALARM•PROT	STOP or REWIND
Playback	The tape automatically rewinds to the beginning and stops.	Stop
Fast Forward	Stop	Stop

SPECIAL EFFECTS PLAYBACK

The VCR features the following convenient functions. Audio output is muted during special effects playback.

STILL PICTURE

Press PAUSE during playback. (A few noise bars or vertical movement may appear during still playback.) Press again to resume playback.

FRAME-BY-FRAME PLAYBACK

You can use the JOG dial to advance the tape frame by frame or field by field.

1. Press PAUSE to freeze the picture while the VCR is playing the tape.
2. Turn the JOG dial right to forward the tape or left to reverse it. To get continuous movement, keep rotating the JOG dial.
3. To freeze the picture again, release the dial.
4. Press PLAY to resume normal playback.

Noise bars or vertical movement may appear during frame-by-frame playback. Noise bars may appear when switching between forward and reverse playback.

SHUTTLE RING

You can set the playback speed using the SHUTTLE ring.

1. Press PAUSE during playback to get a still picture.
2. Turn the SHUTTLE ring right or left to get the playback speed you want.
3. Cancel by pressing PAUSE to get a still picture and then pressing it again to return to the playback.

Playback speed varies according to the angle of the SHUTTLE ring (as shown in Figure 26).

When the SHUTTLE ring is released, it comes back to the center position and the playback picture stays still.

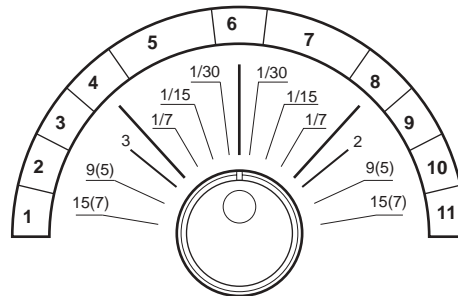

00485

() indicates the playback speed of the recorded tape in 2H mode.

- | | |
|-------------------------------|-------------------------------|
| 1. Reverse high speed search | 7. Slow playback |
| 2. Reverse speed search | 8. Normal playback |
| 3. Reverse fast playback (x3) | 9. Fast playback (x2) |
| 4. Reverse playback | 10. Forward speed search |
| 5. Reverse slow | 11. Forward high speed search |
| 6. Still | |

Figure 26. Shuttle Ring Speed Settings

DIRECT SHUTTLE RING

You can also change the playback speed without entering pause mode by turning the SHUTTLE ring during playback, as shown below.

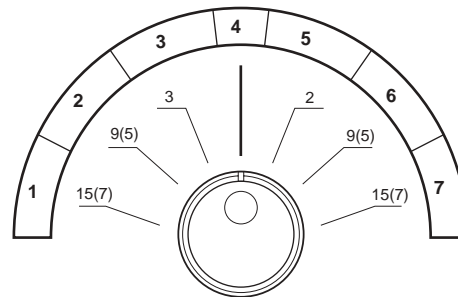

00486

() indicates the playback speed of the recorded tape in 2H mode.

- | | |
|-------------------------------|------------------------------|
| 1. Reverse high speed search | 5. Fast playback (x2) |
| 2. Reverse speed search | 6. Forward speed search |
| 3. Reverse fast playback (x3) | 7. Forward high speed search |
| 4. Normal playback | |

Figure 27. Direct Shuttle Ring Speed Settings

ADJUSTING THE PICTURE DURING PLAYBACK

TRACKING ADJUSTMENT

If noise appears in the picture during playback, reverse/fast playback, fast playback, reverse playback, frame playback, or field playback, you can reduce or eliminate it by adjusting the tracking.

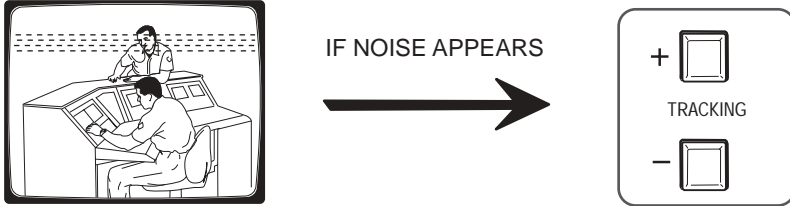

00487

Figure 28. Tracking Adjustment

Adjust tracking at each playback mode or the type of playback (fast, reverse, etc.) since the method of adjusting tracking varies.

Noise bars will move continuously through the picture when holding down a TRACKING button. Noise may also remain although tracking is adjusted during reverse playback or reverse slow playback. Noise may also remain after adjustment when a picture recorded in 6H or 8H mode is played back in L18H, L24H, L30H, or L40H mode.

- To adjust during playback:
Press the TRACKING buttons (+/-) for the best picture.
- To adjust during fast, reverse, forward/reverse slow, frame, or field playback:
 1. During still picture mode, turn the SHUTTLE ring to get the desired playback mode. (If noise appears in the frame or field, set to slow playback.)
 2. While turning the SHUTTLE ring, press PAUSE. The playback picture is fixed at the selected speed.
 3. Release the SHUTTLE ring.
 4. Press the TRACKING buttons (+/-) to get the best picture.
- To reset the tracking:
Press both TRACKING buttons (+/-) together during playback to set tracking to its initial setting.

ADJUSTING PICTURE QUALITY

This control lets you adjust the playback picture so the outline is sharper or softer. It is only effective during playback. During playback, turn the PICTURE control right for sharper or left for softer.

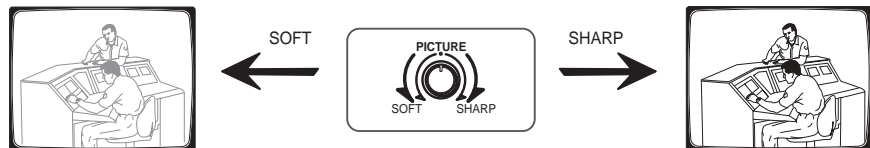

00488

Figure 29. Picture Quality Adjustment

VERTICAL (VIBRATION) ADJUSTMENT

The VERTICAL ADJUST buttons (+/-) will not correct horizontal vibration. Also, they will not work when QUASI V-SYNC in the First Time Set Up menu is set to OFF.

- If the picture vibrates when watching still, slow motion, fast playback, or normal playback in L18H through 22H or 0H modes:
 1. Press PAUSE during playback.
 2. Press the VERTICAL ADJUST buttons (+/-) to reduce or eliminate picture vibration.
- To reset vertical adjustment:

Press both the VERTICAL ADJUST buttons (+/-) together during still picture, forward or reverse slow playback, or playback in L18H through 22H or 0H modes.



00489

Figure 30. Vertical Picture (Vibration) Adjustment

SEARCH TECHNIQUES

COUNTER MEMORY STOP

This feature rewinds a tape until the counter on the fluorescent display reaches 00000 and stops. (NOTE: When the counter indicates 00000, COUNTER MEMORY STOP on the Search Function menu cannot be selected.)

1. Press the SEARCH button once. The Search Function menu appears with COUNTER MEMORY STOP highlighted. The counter memory stop indicator (M) on the fluorescent display lights.

To exit the Search Function menu without rewinding, press STOP.

2. Turn the SHUTTLE ring right. The VCR starts rewinding the tape.
3. Press STOP to quit rewinding.

SKIP SEARCH

The VCR automatically inserts an index signal at the beginning of each alarm recording, so the start of each alarm can be located. During fast forwarding or rewinding, the VCR plays back a tape (in 2H, 6H, or 8H mode) for about four seconds where an index signal is recorded. It repeats this process until reaching the end or beginning of the tape.

1. Press the SEARCH button enough times to highlight SKIP SEARCH on the Search Function menu. The skip search indicator (SKIP) on the fluorescent display lights.

To exit the Search Function menu without searching, press STOP.

2. Turn the SHUTTLE ring right (search forward) or left (search backward) to start searching.
3. When you find a picture you want to view, press PLAY.
4. To quit searching, press STOP.

The index signal may be hard to find under some recording conditions. Skip search may not function if the interval between two alarm recordings start times is too short. Refer to Table G for minimum intervals.

Audio output is muted during skip search.

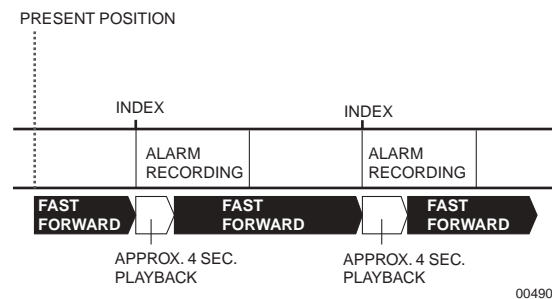

Figure 31. Skip Search

INDEX SEARCH

The VCR automatically inserts an index signal at the beginning of each alarm recording, so the start of each alarm can be located. During fast forwarding or rewinding, the VCR can search for an alarm index signal you have selected. When the VCR finds it, the VCR plays back the tape in still mode.

1. Press the SEARCH button enough times to highlight INDEX SEARCH on the Search Function menu. The index search indicator (INDEX) on the fluorescent display lights.

To exit the Search Function menu without searching, press STOP.

2. Turn the JOG dial to select an index number (between 1 and 255) you want to find.
3. Turn the SHUTTLE ring right (search forward) or left (search backward) to start searching. The index number in the fluorescent display decreases by one as each index signal goes by.
4. To quit while searching, press STOP.

The index signal may be hard to find under some recording conditions. Index search may not function if the interval between two alarm recordings start times is too short. Refer to Table G for minimum intervals.

HOW TO COUNT THE INDEX NUMBER

The index number is the count from the present position. The index number of one alarm recording before the present position is -1 . The index number of one alarm recording after is $+1$.

The maximum count of alarm recordings is ± 255 .

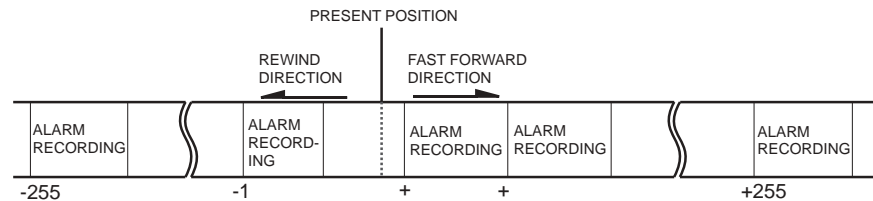

Figure 32. Index Searching

00491

TIME AND DATE SEARCH

You can find a picture recorded at a specific date and time.

1. Press the SEARCH button enough times to highlight TIME DATE SEARCH on the Search Function menu. The time and date search indicator (D) on the fluorescent display lights.
2. Turn the SHUTTLE ring right. The Time Date Search menu appears.

Turn the SHUTTLE ring left several times to exit the Time Date Search menu without searching.
3. Turn the JOG dial to set the digits for the hour you want to find next to TIME. Turn the SHUTTLE ring right.
4. Set the 10-minute and 1-digits in the same way.
5. Set the date using the JOG dial and SHUTTLE ring in the same manner.
6. Set the direction (forward or reverse) in which to search the tape using the JOG dial and SHUTTLE ring.

(When the desired part of the tape is not found in the selected direction, the VCR automatically searches in the opposite direction.)
7. Turn the SHUTTLE ring right to begin searching. When the recorded picture is found, it is shown in still mode.
8. To quit while searching, press STOP.

The VCR writes an index mark on the tape at each hour (1:00, 2:00, etc.) during recording. The time and date search cannot be resumed if the hour's index mark (set in step 3) is not recorded on the tape. (For example, if the VCR recorded from 8:15 to 17:30 on the tape, only pictures between 9:00 and 17:30 can be found.)

The time and date search may not function correctly if you used a tape with poor recording quality or with alarm recordings in several recording modes. Also, it will not function with a tape recorded with other VCRs or with a tape recorded without setting the date and time.

ADDITIONAL FUNCTIONS AND FEATURES

COUNTER

TAPE COUNTER

A five-digit counter indicates the relative position on the recorded portion of the tape.

COUNTER RESET

Press the COUNTER RESET button to reset the counter to 00000.

COUNTER MEMORY

The counter display is stored in memory when the power is turned off, so the same numbers are displayed when power is restored. (Refer to the Counter Memory Stop section for information and procedures for rewinding to 00000.)

MEMORY BACKUP IN CASE OF POWER FAILURE

NOTE: *The backup is for memory only—the VCR will not continue recording during a power outage unless connected to a UPS.*

The VCR includes a built-in memory backup so the settings for time and date, timer program, alarm list, power loss list, number of tape uses, elapsed VCR time, counter display, and recording and playback mode will remain in memory if there is a power failure or the power cord is unplugged for a long period (more than one month). The settings remain in memory for up to 31 days provided the VCR has been connected to AC power for at least 40 hours per week. Connection charges the battery backup.

However, if the power cord is unplugged for a long period (more than one month), the time may be wrong. If so, set the clock again.

When ALARM REC DURATION in the Recording Set Up menu is set to MAN1 or MAN2 and the power fails during recording, the VCR may not return to the alarm recording mode when power is restored.

RESET BUTTON

If the VCR is not working correctly or is showing an unusual indication on the fluorescent display, you can press the RESET button on the rear panel with a pointed object. This sets the following default values and turns the VCR off:

- Date and time
- Alarm list
- Power loss list
- Counter display
- Recording mode
- Playback mode

To restart the VCR, press the POWER button. Set the day and time.

EXTERNAL TIME CLOCK ADJUSTMENT

You can set the VCR's clock to the nearest hour by connecting with an external clock. When two or more VCRs are connected together, the clock can be set to the first VCR's clock. Make the following settings to all VCRs you want set to the clock. Refer to the *Connecting for External Time Clock Adjustment* section for connection instructions.

1. Press the MENU button. The Main menu appears.
2. Set ALARM REC DURATION on the Recording Set Up menu to **other than MAN1**.
3. Set MODE OUT on the Rear Terminal menu to CLOCK ADJ.
4. Press the MENU button. The day and time display appears.

HOW EXTERNAL TIME ADJUSTMENT WORKS

When the RST IN terminal is grounded at the rear panel, the clock is set to the nearest hour automatically. For example:

- When the display shows 11:29:59, the clock is adjusted to 11:00:00.
- When the display shows 11:30:00, the clock is adjusted to 12:00:00.

When more than two VCRs are connected and the first VCR's clock is adjusted to the nearest hour, the additional VCRs will also be set to the nearest hour.

USING WITH A PC

Refer to the *Connecting the VCR to a PC* and *Connecting to a PC for Remote Control* sections for information about connection, protocol, data communication settings, and cable connections.

ASSIGNING THE RS-232C SETTINGS

Assign the RS-232C interface board setting using the VCR's on-screen menu, as follows:

1. Press the MENU button. The Main menu appears.
2. Turn the JOG dial to select CLOCK/FIRST TIME SET UP, and then turn the SHUTTLE ring right. The First Time Set Up menu appears.
3. Turn the JOG dial to select RS-232C, and then turn the SHUTTLE ring right. The RS-232C menu appears.
4. Change the parameter value by turning the JOG dial left or right, and then turning the SHUTTLE ring right to store the new value.
 - Set all parameters for the VCR to the same values as the controlling PC or other equipment.
 - PARITY BIT cannot be used when DATA BIT LENGTH is set to 8BIT.
 - When controlling only one VCR via the PC, set VCR ADDRESS to NONE.
 - VCRs can be remotely controlled via a PC when each VCR has a unique VCR ADDRESS (from VCR01 to VCR255).
5. Repeat step 4 until all the items are set. The First Time Set Up menu appears after setting VCR ADDRESS.
6. Press the MENU button. The day and time display appears.

COMMANDS FROM A PC

This section covers the commands sent from the PC (or other equipment) to the VCR and the VCR's responses.

WHEN CONTROLLING ONLY ONE VCR

Set VCR ADDRESS in the RS-232C menu to NONE when controlling only one VCR via the PC.

Command: Commands sent to the VCR.

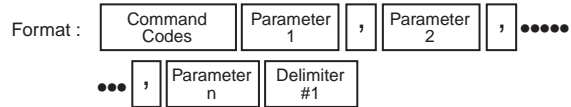

Status : Response codes from the VCR.

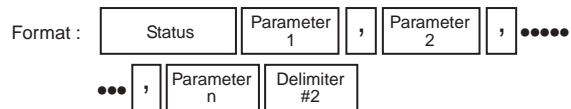

00492

Figure 33. Commands When Controlling One VCR

- When you set DELIMITER<RECEIVE> to CR, input the carriage return code (0DH).
When you set DELIMITER<RECEIVE> to CR•LF, input the carriage return code (0DH) and line feed code (0AH).
- When you set DELIMITER<SEND> to CR, the carriage return code (0DH) will be input.
When you set DELIMITER<SEND> to CR•LF, the carriage return code (0DH) and line feed code (0AH) will be input.

Example 1

Switch on the VCR (when DELIMITER<SEND> and DELIMITER<RECEIVE> of the RS-232C menu are set to CR).

Sending Commands from the PC, etc.	Status or Error Code from the VCR to PC, etc.	Meaning
PW1 CR	RC CR EX CR	Power ON command Command received Command carried out

CR indicates carriage return code (0DH).

Example 2

Recording was attempted, but failed because the cassette's erasure prevention tab was broken (when DELIMITER<SEND> and DELIMITER<RECEIVE> of the RS-232C menu are set to CR).

Sending Commands from the PC, etc.	Status or Error Code from the VCR to PC, etc.	Meaning
RC CR	RC CR ER02 CR	Command for recording Command received Failed because the tape's erasure prevention tab is broken

CR indicates carriage return code (0DH).

WHEN CONTROLLING MULTIPLE VCERS

Set VCR ADDRESS for each VCR in the RS-232C menu to different addresses (from VCR01 to VCR255, except NONE).

- When you want to control a specific VCR, enter its address (for example, VCR01) and a comma before entering the command code.
- When you want to control all connected VCERS, enter ALL and a comma before entering the command code.

Command: Commands sent to the VCR.

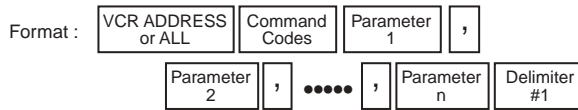

Status : Response codes from the VCR to outside.

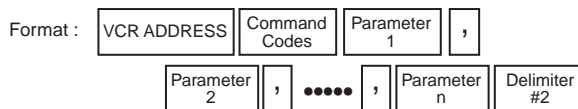

00493

Figure 34. Commands When Controlling Multiple VCERS

- When you set DELIMITER<RECEIVE> to CR, input the carriage return code (0DH).
When you set DELIMITER<RECEIVE> to CR•LF, input the carriage return code (0DH) and line feed code (0AH).
- When you set DELIMITER<SEND> to CR, the carriage return code (0DH) will be input.
When you set DELIMITER<SEND> to CR•LF, the carriage return code (0DH) and line feed code (0AH) will be input.

Example 1

Fast forward the tape in the VCR identified as VCR02 (when DELIMITER<SEND> and DELIMITER<RECEIVE> on the RS-232C menu are set to CR).

Sending Commands from the PC, etc.	Status or Error Code from the VCR to PC, etc.	Meaning
VCR02, FF CR	VCR02, RC CR VCR02, EX CR	Command for fast forwarding (VCR02) Command received (VCR02) Command carried out (VCR02)

CR indicates carriage return code (0DH).

Example 2

Set the clocks to 12:27 on all the connected VCRs (when DELIMITER<SEND> and DELIMITER<RECEIVE> on the RS-232C menu are set to CR).

Sending Commands from the PC, etc.	Status or Error Code from the VCR to PC, etc.	Meaning
ALL,SC12,27 CR	VCR01, RC CR	Command for recording
	VCR01, EX CR	Command received (VCR01)
	•	Command carried out (VCR01)
	•	•
	•	•
	VCR255, RC CR	Command received (VCR255)
VCR255, EX CR	Command carried out (VCR255)	

CR indicates carriage return code (0DH).

The order and number of the status responses from the VCRs to the PC or other controller may vary depending on the number of VCRs and ID number settings.

COMMANDS AND RESPONSES CHART

The chart uses the following conventions:

- * An asterisk indicates a character or digit (for example, *** indicates three characters or digits).
- #1 This means input the code according to the DELIMITER<RECEIVE> setting (CR [0DH] or CR [0DH] + LF [0AH]).
- #2 This means the code according to the DELIMITER<SEND> setting (CR [0DH] or CR [0DH] + LF [0AH]) will be input).

No.	Commands	Functions	Status After Normal Execution	Explanation of Status
1	PW#1	Power ON/OFF	RC#2EX#2	Command received and carried out
2	PW0#1	Power OFF	Same as above	Same as above
3	PW1#1	Power ON	Same as above	Same as above
4	EJ#1	Eject	Same as above	Same as above
5	SP#1	Stop	Same as above	Same as above
6	PB#1	Playback	Same as above	Same as above
7	RP#1	Reverse playback	Same as above	Same as above
8	FF#1	Fast forward	Same as above	Same as above
9	RW#1	Rewind	Same as above	Same as above
10	RC#1	Recording	Same as above	Same as above
11	CM#1	Counter memory stop	Same as above	Same as above
12	PU#1	Pause ON/OFF	Same as above	Same as above
13	PU0#1	Pause OFF	Same as above	Same as above
14	PU1#1	Pause ON	Same as above	Same as above
15	FA#1	Frame advance (when still)	Same as above	Same as above
16	RA#1	Reverse frame advance (when still)	Same as above	Same as above
17	LK#1	Lock OFF	Same as above	Same as above
18	LK0#1	Lock ON	Same as above	Same as above
19	LK1#1	Lock All ON	Same as above	Same as above
20	SF#1	Skip search (forward)	Same as above	Same as above
21	SR#1	Skip search (reverse)	Same as above	Same as above
22	IF***#1	Index search (forward) up to (**#=001-255)	Same as above	Same as above
23	IR***#1	Index search (reverse) up to (**#=001-255)	Same as above	Same as above
24	IN#1	Inquiry about current index no. (during index search)	RC#2D***#2	Index no. is **#=001-255
25	TR#1	Timer recording ON/OFF	RC#2EX#2	Command received and carried out
26	TR0#1	Timer recording OFF	Same as above	Same as above
27	TR1#1	Timer recording ON	Same as above	Same as above
28	TP#1	Inquiry about current executing timer program no.	RC#2TN*#2	Timer program no. is *=1-8 (NOTE: ER08 when not timer recording.)

(Continued on next page)

No.	Commands	Functions	Status After Normal Execution	Explanation of Status
29	SS#1	Inquiry about current VCR status	RC#2ST00#2	Power off, cassette in
			RC#2ST01#2	Power off, cassette out
			RC#2ST02#2	Power on, cassette in
			RC#2ST03#2	Power on, cassette out
			RC#2ST04#2	Fast forward underway
			RC#2ST05#2	Rewind underway
			RC#2ST06#2	Recording underway
			RC#2ST07#2	Recording pause underway
			RC#2ST08#2	Playback underway
			RC#2ST09#2	Reverse playback underway
			RC#2ST10#2	Forward speed search underway
			RC#2ST11#2	Reverse speed search underway
			RC#2ST12#2	Still underway
			RC#2ST13#2	Counter memory stop underway
			RC#2ST14#2	Skip search (forward) underway
			RC#2ST15#2	Skip search (reverse) underway
			RC#2ST16#2	Playback during skip search
			RC#2ST17#2	Index search (forward) underway
			RC#2ST18#2	Index search (reverse) underway
			RC#2ST19#2	Rewind during repeat recording
			RC#2ST20#2	Alarm recording underway
			RC#2ST21#2	Timer recording underway
			RC#2ST22#2	Standby for timer recording
			RC#2ST23#2	Timer recording error underway
			RC#2ST24#2	Time date search standby underway
			RC#2ST25#2	Time date search (forward) underway
			RC#2ST26#2	Time date search (reverse) underway
			RC#2ST27#2	Time date search or point adjustment underway
RC#2ST29#2	Recording check underway			
RC#2ST30#2	Alarm recording index writing underway			
RC#2ST31#2	Time date index writing underway			
RC#2ST32#2	One-shot recording underway			
RC#2ST33#2	Frame advance underway			
RC#2ST34#2	Reverse frame advance underway			
30	LO*#1	Lock ON/OFF or Lock All ON/OFF (* : 0=OFF, 1=ON)	RC#2EX#2	Command received and carried out
31	LM#1	Inquiry about current lock status and lock mode	RC#2LM*#2	* : 0=Lock off, 1=Lock on, 2=Lock All on
32	CR#1	Counter reset	RC#2EX#2	Command received and carried out
33	CT#1	Inquiry about current counter display value	RC#2CT*****#2	*****=00000-99999
34	MC***#1	Switch over REC/PLAY mode to ***=002, 006, L18, L30, 048, 072, 096, 120, 168, 000	RC#2EX#2	Command received and carried out
35	MD#1	Inquiry about current REC/PLAY mode	RC#2MD***(*)#2	Same as item 34

(Continued on next page)

No.	Commands	Functions	Status After Normal Execution	Explanation of Status
36	DP#1	Change menu to the next layer	RC#2EX#2	Command received and carried out
37	DP***#1	Switch screen page to (***: 000=present time display 100=Main menu 110=Display menu 120=Search Function menu 121=Time Date Search menu 130=Timer Program menu 131=Program To Record menu 132=Holiday Set Up menu 140=Recording Set Up menu 150=Rear Terminal menu 160=Maintenance menu 161=Power Loss List 162=Alarm List 163=All Menu Initialize 164=Power Loss List Clear 165=Alarm List Clear 170=First Time Set Up menu 171=Time Date Adjust menu 172=RS-232C menu	Same as above	Same as above
38	PI#1	Inquiry about current screen page	RC#2ON*** ⁽¹⁾ * ⁽²⁾ #2	*** ⁽¹⁾ : Same as item 37 050=Language Select menu * ⁽²⁾ : 0=Setting completed 1=Setting underway
39	SD** ⁽¹⁾ ,** ⁽²⁾ , ** ⁽³⁾ #1	Current date setting ** ⁽¹⁾ : Month, ** ⁽²⁾ : Day, ** ⁽³⁾ : Year	RC#2EX#2	Command received and carried out
40	DT#1	Inquiry about current date	RC#2TD** ⁽¹⁾ ,** ⁽²⁾ ,** ⁽³⁾ , * ⁽⁴⁾ #2	** ⁽¹⁾ ,** ⁽³⁾ : Same as item 39 * ⁽⁴⁾ : Day of the week 0=SUN, 1=MON, 2=TUE, 3=WED, 4=THU, 5=FRI, 6=SAT
41	SC** ⁽¹⁾ ,** ⁽²⁾ #1	Current time setting ** ⁽¹⁾ : Hour, ** ⁽²⁾ : Minute	RC#2EX#2	Command received and carried out
42	TM#1	Inquiry about current time	RC#2TI** ⁽¹⁾ ,** ⁽²⁾ , ** ⁽³⁾ #2	** ⁽¹⁾ : Hour, ** ⁽²⁾ : Minute, ** ⁽³⁾ : Second
43	TD#1	Inquiry about power failure symbol	RC#2MK*#2	*: 0=Not displayed, 1=Displayed
44	PS** ⁽¹⁾ ,** ⁽²⁾ #1	Time and date display position ** ⁽¹⁾ : Horizontal =01-30 (mode 1, size large) =01-52 (mode 1, size small) =01-39 (mode 2,3, size large) =01-62 (mode 2,3, size small) ** ⁽²⁾ : Vertical =01-37 (mode 1, size large or small) =01-35 (mode 2,3, size large or small)	RC#2EX#2	Command received and carried out
45	LC#1	Inquiry about time and date display position	RC#2LT** ⁽¹⁾ ,** ⁽²⁾ #2	** ⁽¹⁾ , ** ⁽²⁾ : Same as item 44
46	PG* ⁽¹⁾ ,* ⁽²⁾ ,** ⁽³⁾ , ** ⁽⁴⁾ ,** ⁽⁵⁾ ,** ⁽⁶⁾ , *** ⁽⁷⁾ ,* ⁽⁸⁾ #1	Timer program setting * ⁽¹⁾ Program no.=1-8 * ⁽²⁾ Day of week (0=SUN, 1=MON, 2=TUE, 3=WED, 4=THU, 5=FRI, 6=SAT) ** ⁽³⁾ Rec starting hour=00-23 ** ⁽⁴⁾ Rec starting minute=00-59 ** ⁽⁵⁾ Rec ending hour=00-23 ** ⁽⁶⁾ Rec ending minute=00-59 *** ⁽⁷⁾ Rec time mode=Same as item 34, SKP * ⁽⁸⁾ REC mode 1=EP, 3=EP/EXT (EXT=external timer recording)	RC#2EX#2	Command received and carried out. (NOTE: An error [ER08] occurs if you try to program a timer program number that has already been set. Clear the timer program contents with the "CA" command, and then retry.)
47	PM*#1	Inquiry about setting contents of timer program no. (*=1-8)	RC#2MP* ⁽¹⁾ ,* ⁽²⁾ , ** ⁽³⁾ ,** ⁽⁴⁾ ,** ⁽⁵⁾ , ** ⁽⁶⁾ ,*** ⁽⁷⁾ ,* ⁽⁸⁾ #2	* ⁽¹⁾ - ⁽⁸⁾ Same as item 46

(Continued on next page)

No.	Commands	Functions	Status After Normal Execution	Explanation of Status
48	CA*#1	Clear contents of timer program no. (*=1-8)	RC#2EX#2	Command received and carried out
49	DW*(1),*(2)#1	Setting the special day of the week *(1) : Start day of week (0-6) *(2) : End day of week (0-6) 0=SUN, 1=MON, 2=TUE, 3=WED, 4=THU, 5=FRI, 6=SAT	Same as above Cannot accept this command when *(1) and *(2) are the same number.	Same as above
50	DW?#1	Inquiry about the setting for the special day of the week	RC#2DW*(1),*(2)#2	*(1) : Start day of week (0-6) *(2) : End day of week (0-6) 0=SUN, 1=MON, 2=TUE, 3=WED, 4=THU, 5=FRI, 6=SAT
51	AM**#1	Alarm recording mode setting **=06, 18, 30	RC#2EX#2	Command received and carried out
52	AS1#1	Inquiry about alarm recording mode setting	RC#2AM**#2	**=06, 18, 30
53	AD*#1	Alarm REC duration setting * : 0=MAN1, 1=MAN2, 2=15S, 3=30S, 4=45S, 5=1M, 6=2M, 7=5M, 8=10M	RC#2EX#2	Command received and carried out
54	AS0#1	Inquiry about alarm REC duration setting	RC#2AP*#2	*=Same as item 53
55	EM#1	Emergency REC ON/OFF	RC#2EX#2	Command received and carried out
56	EM0#1	Emergency REC OFF	Same as above	Same as above
57	EM1#1	Emergency REC ON	Same as above	Same as above
58	AS2#1	Inquiry about emergency REC setting	RC#2EG*#2	* : 0=OFF, 1=ON
59	TE*#1	Tape end movement setting * : 0=STOP, 1=REWIND, 2=REPEAT, 3=ALARM•PROT (protect)	RC#2EX#2	Command received and carried out
60	FS0#1	Inquiry about tape end movement setting	RC#2TE*#2	*=Same as item 59
61	DM*#1	Display mode setting *=1-4	RC#2EX#2	Command received and carried out
62	DM?#1	Inquiry about display mode setting	RC#2DM*#2	*=1-4
63	CH0#1	Set date character display size "SMALL"	RC#2EX#2	Command received and carried out
64	CH1#1	Set date character display size "LARGE"	Same as above	Same as above
65	FS1#1	Inquiry about date character display size	RC#2CZ*#2	* : 0=SMALL, 1=LARGE
66	CO*(1),**(2)#1	Clock out setting *(1) : 0=REC, 1=T/L REC **(2) : 01, 02, 03, 04, 05, 10, 15, 20, 25, 30, 50, 60, 00 (output by field)	RC#2EX#2	Command received and carried out
67	RO#1	Inquiry about clock out setting	RC#2CD*(1),**(2)#2	*(1),**(2) Same as item 66
68	MO*#1	Mode out setting * : 0=REC, 1=PLAY, 2=POWER, 3=TAPE, 4=TAPE REMAIN, 5=CLOCK ADJ	RC#2EX#2	Command received and carried out
69	RM#1	Inquiry about mode out setting	RC#2MR*#2	*=Same as item 68
70	CU*#1	Call out setting * : 0=OFF, 1=ON Receive command only when signal at CALL OUT terminal is switched to active condition.	RC#2EX#2	Command received and carried out
71	CU?#1	Inquiry about call out setting	RC#2CU*#2	* : 0=OFF, 1=ON
72	BL*#1	Blue background setting * : 0=OFF, 1=ON	RC#2EX#2	Command received and carried out
73	BL?#1	Inquiry about blue background setting	RC#2BL*#2	* : 0=OFF, 1=ON

(Continued on next page)

No.	Commands	Functions	Status After Normal Execution	Explanation of Status
74	ST*#1	Set menu item to flash * : 0=OFF, 1=ON	RC#2EX#2	Command received and carried out
75	BZ*#1	Buzzer setting * : 0=WRNG, 1=WRNG•TAPE END, 2=WRNG•REMAIN, 3=OFF	Same as above	Same as above
76	BR*#1	Buzzer on/off setting * : 0=OFF, 1=ON	Same as above	Same as above
77	FS2#1	Inquiry about buzzer setting	RC#2BZ*#2	*=Same as item 75
78	BP#1	Inquiry about buzzer status	RC#2SW*#2	* : 0=OFF (not ring), 1=ON (ring)
79	OS**#1	One-shot field setting ** : 01, 02, 03, 04, 05, 10, 20, 30	RC#2EX#2	Command received and carried out
80	OF#1	Inquiry about one-shot field setting	REC#2SD**#2	**=Same as item 79
81	OI*#1	One-shot interval setting * : 0=SHOT, 1=10S, 2=15S, 3=30S, 4=45S, 5=1M, 6=2M, 7=3M	RC#2EX#2	Command received and carried out
82	OI?#1	Inquiry about one-shot interval setting	RC#2OI*#2	*=Same as item 81
83	AN#1	Inquiry about current alarm REC no.	RC#2AN****#2	****=0000-9999
84	AT*#1	Inquiry about alarm list * : 0=about the 1st alarm recording 1-7=about the last to 7th last alarm recording	RC#2AT**(1),**(2),**(3), **(4),**(5)#2	**(1) : Month, **(2) : Day, **(3) : Year, **(4) : Hour, **(5) : Minute
85	CA#1	Clearing alarm list	RC#2EX#2	Command received and carried out
86	PN#1	Inquiry about current power loss list no.	RC#2PN**#2	**=00-99
87	PT*#1	Inquiry about power loss list * : 0=about the 1st power loss 1=about the 2nd power loss 2=about the last power loss	RC#2PT**(1),**(2),**(3), **(4),**(5)#2	**(1) : Month, **(2) : Day, **(3) : Year, **(4) : Hour, **(5) : Minute
88	PC#1	Clearing power loss list	RC#2EX#2	Command received and carried out
89	MI#1	Initializing the menu setting	Same as above	Same as above
90	HM?#1	Inquiry about the elapsed time	RC#2HM*****#2	*****=hour
91	WN#1	Inquiry about warning information	RC#2WN**#2	** : Warning no. 0=no malfunction, 01=tape end, 03=video input missing, 04=clogged head, 05=reel rotation trouble, 06=loading motor trouble, 07=capstan motor trouble, 08=drum motor trouble, 09=tape loose, 10=switching power short, 11=cut tape
92	CA0#1	Clearing the warning "ER05"	RC#2EX#2	Command received and carried out
93	RI*#1	REC IN setting * : 0=SERIES, 1=REC-START/STOP, 2=SYNC REC	Same as above	Same as above
94	RI?#1	Inquiry about REC IN setting	RC#2RI*#2	*=Same as item 93
95	QV*#1	Quasi v-sync setting * : 0=OFF, 1=ON	RC#2EX#2	Command received and carried out
96	QM#1	Inquiry about quasi v-sync setting	RC#2QV*#2	* = 0=OFF, 1=ON
97	CL*#1	Call out setting * : 0=WRNG, 1=WRNG•TAPE END, 2=WRNG•REMAIN	RC#2EX#2	Command received and carried out
98	RL#1	Inquiry about call out setting	RC#2CL*#2	*=Same as item 97

(Continued on next page)

No.	Commands	Functions	Status After Normal Execution	Explanation of Status
99	SM*#1	Daylight saving setting * : 0=OFF, 1=ON, 2=AUTO	RC#2EX#2	Command received and carried out
100	SM?#1	Inquiry about daylight saving setting	RC#2SM*#2	* =0=OFF, 1=ON, 2=AUTO OFF, 3=AUTO ON
101	RS?#1	Inquiry about repeat rec times	RC#2RS***#2 or RC#2RSOVER#2	*** : 000-200 or OVER (more than 201 times)
102	TL*#1	Tape length setting * : 0=T-120, 1=T-160	RC#2EX#2	Command received and carried out
103	TL?#1	Inquiry about tape length setting	RC#2TL*#2	*=Same as item 102
104	LP?#1	Inquiry about tape remaining time	RC#2LP*(1),**(2)#2	*(1) : Hour, *(2) : Minute
105	TF**(1),**(2), ***(3)#1	Time and date search (forward) setting ***(1) : Day, *(2) : Hour, *(3) : Minute	RC#2EX#2	Command received and carried out
106	TB**(1),**(2), ***(3)#1	Time and date search (reverse) setting ***(1) : Day, *(2) : Hour, *(3) : Minute	Same as above	Same as above
107	TS?#1	Inquiry about time and date search setting	RC#2TS**(1),**(2),***(3)#2	***(1) : Day, *(2) : Hour, *(3) : Minute
108	MQ*#1	Video mode setting * : 1=B/W, 2=AUTO	RC#2EX#2	Command received and carried out
109	SB1#1	Inquiry about video mode	RC#2SQ*#2	*=Same as item 108
110	MM*#1	Menu language selection * : 0=English, 1=French, 2=Spanish	RC#2EX#2	Command received and carried out
111	SB3#1	Inquiry about selected menu language	RC#2SP*#2	*=Same as item 110 8=Language is not selected
112	RN?#1	Inquiry about recording/BNC mode, SP/EP	RC#2EX#2	* : 0=SP, 2=EP
113	SV?#1	Inquiry about recording format	RC#2SV*#2	* : 0=VHS, 2=Super resolution
114	HL**(1),**(2), ***(3)#1	Holiday set up setting ***(1) : Position no. 01-20, *(2) : Month, *(3) : Day	RC#2EX#2	Command received and carried out
115	EH**#1	Clearing holiday set up setting ** : Position no. 01-20	Same as above	Same as above
116	HC*#1	Inquiry about holiday set up setting on line 01 to 05 * : Line no. 01-05	RC#2HC**(1),**(2), ***(1),***(2),***(1),***(2),***(1), ***(2),***(1),***(2)#2	***(1) : Month, *(2) : Day
117	CG*#1	Clog detection ON/OFF * : 0=OFF, 1=ON	RC#2EX#2	Command received and carried out
118	CG?#1	Inquiry about clog detection setting	RC#2CG*#2	* : 0=OFF, 1=ON
119	HR#1	Super resolution ON/OFF	RC#2EX#2	Command received and carried out
120	HR0#1	Super resolution OFF	Same as above	Same as above
121	HR1#1	Super resolution ON	Same as above	Same as above
122	HR?#1	Inquiry about super resolution setting	RC#2HR*#2	* : 0=OFF, 1=ON

ERROR CODES

No.	Error	Meaning of Error
1	ER01	No power supply
2	ER02	No cassette loaded
3	ER03	Broken tape tab (unable to record)
4	ER04	Beginning of the tape
5	ER05	Tape end
6	ER06	Problem with the tape, video input, or VCR mechanism
7	ER07	Present time or timer program not yet set
8	ER08	Alarm REC underway (unable to change setting)
9	ER09	Unfeasible
10	ER10	Incorrect command
11	ER11	Incorrect parameter
12	ER12	Overflow of the VCR's command receive buffer
13	ER13	Data not received correctly

TESTING

INITIAL SYSTEM TESTING

Before using the newly installed surveillance system, do the following:

- Make test recordings at the time-lapse speeds you will be using. Test how the system performs with alarms.
- Interrupt electrical power to check your installed power backup system (if applicable).
- On playback, verify picture quality and that you can see the time and date display under normal and alarm conditions.

REGULAR SYSTEM TESTING

- Every day check that the system is operating. Is the recording indicator lit? Does the counter display indicate movement? Does the monitor show proper camera sequencing and time and date information?
- Check for recorded alarms. Multiple alarms could make the tape run out early. Make sure there is enough tape to record at least five minutes of alarm activity at the selected speed.
- Regularly verify picture quality and operation under normal and alarm conditions. Play a tape recorded recently under normal conditions, which also includes an alarm condition that you triggered manually.
- Regularly replace tapes (refer to Table C for a schedule). Check tapes for head scarring. Replace damaged tapes. Always store tapes in their boxes, away from magnetic fields, heat, direct sunlight, and dust.

TROUBLESHOOTING

SELF-DIAGNOSTIC FUNCTION AND WARNING DISPLAY

The VCR uses self-diagnostics to detect internal malfunctions during recording. If one occurs, the VCR indicates it on the fluorescent display and/or the monitor. Table J shows the type of malfunction corresponding to the warning display and the action to take.

Table J. Warning Display and Actions

Fluorescent Display	Monitor	Cause	Remedy	To Turn Off Indicator
End	TAPE END	Tape ends during recording.	Rewind tape or press EJECT.	Rewind tape or press EJECT.
noSlg	NO SIGNAL	No video signal input during recording.	Check for loose connections.	Restore video signal or clear recording mode.
(display starts flashing)	CHECK	Tape or deck trouble during recording.	Check cassette. If nothing is wrong, try recording again. If "CHECK" still appears, insert a new cassette and retry recording. If "CHECK" stays on, unplug the power cord and contact the dealer.	
CLog	---	Clogged head during recording at 120H-224H or 0H (except for 128H) mode.	Eject and reinsert the cassette. Wait more than 5 seconds. Repeat 4 or 5 times. Try recording again. If "CLog" remains, consult your dealer.	Clear the recording mode.

- When the tape ends:

When the tape reaches its end during recording, "End" appears on the fluorescent display and "TAPE END" appears on the monitor. They will not appear if TAPE END in the First Time Set Up menu is set to REPEAT, ALARM•PROT (when no alarm recording is made), or REWIND.

- Lack of video signal:

"NO SIGNAL" appears on the monitor and "noSlg" flashes on the fluorescent display when the VCR cannot get any video signal during recording. Check that the cable from the camera is not broken and the camera has power.

- Clogged head:

When CLOG DETECT in the Recording Set Up menu is set to ON, the VCR automatically removes particles that have accumulated on the heads during recording at 120H-224H or 0H modes (except for 128H mode). If they cannot be removed entirely, "CLog" flashes on the fluorescent display. If this happens, follow the remedy in Table J.

BEFORE CALLING FOR SERVICE

If you cannot solve your problem after checking the following list, stop using the VCR, unplug it from the outlet, and contact your dealer.

SYMPTOM	REMEDY
INSTALLATION PROBLEMS	
No power at the VCR.	<ul style="list-style-type: none"> Is the power cord disconnected at the AC outlet? Is the lock or lock all indicator lit? Refer to the separate Caution sheet. See your supervisor if the sheet is not attached to this manual. Is the timer recording indicator lit? Press the TIMER REC button on the front panel to cancel timer recording.
The VCR power is on but the unit does not operate.	<ul style="list-style-type: none"> Is the lock or lock all indicator lit? Refer to the separate Caution sheet. See your supervisor if the sheet is not attached to this manual. Safety devices are operating. Press the RESET button on the rear panel using a ballpoint pen or pencil. Turn power on again.
No picture on the monitor.	<ul style="list-style-type: none"> Are the monitor and camera connected properly. Check the connection. Is the video cable connected properly? Is the cable defective? Check the connection and for a snapped wire in the cable.
Picture on the monitor is not clear.	Is the camera focused? Refer to your camera's user manual and focus the camera properly.
FUNCTION/OPERATION PROBLEMS	
No operation when any tape operation button is pressed.	<ul style="list-style-type: none"> Is the lock or lock all indicator lit? Refer to the separate Caution sheet. See your supervisor if the sheet is not attached to this manual. Is a cassette inserted?
The time is wrong even though the VCR is used every day.	Make sure the VCR has AC power supplied continuously for at least 40 hours per week.
The power cord was disconnected for less than 31 days but the time has been reset.	<ul style="list-style-type: none"> Make sure the VCR has AC power supplied continuously for at least 40 hours per week. Contents stored in memory may be erased before the 31 days depending on the charge time of the power failure compensation circuit. Set the time again.
A tape cannot be loaded.	Is the lock all indicator lit? Refer to the separate Caution sheet. See your supervisor if the sheet is not attached to this manual.

RECORDING PROBLEMS	
Recording does not work by pressing REC.	<ul style="list-style-type: none"> • Is the lock all indicator lit? Refer to the separate Caution sheet. See your supervisor if the sheet is not attached to this manual. • Is the cassette's erasure prevention tab broken off? Load a cassette with an erasure prevention tab. • Has the tape run out? Rewind or load a new cassette.
Cannot stop recording by pressing STOP.	<ul style="list-style-type: none"> • Is the lock or lock all indicator lit? Refer to the separate Caution sheet. See your supervisor if the sheet is not attached to this manual. • Is the timer recording indicator lit? Press the TIMER REC button on the front panel to cancel timer recording.
Repeat recording does not work.	<ul style="list-style-type: none"> • Is the repeat indicator lit? Set TAPE END in the First Time Set Up menu to REPEAT or ALARM•PROT. • If TAPE END is set to ALARM•PROT, repeat recording will not work if there is an alarm recording on the tape. • When a tape reaches its end during emergency recording (recording started while the VCR is stopped or VCR power is off), the VCR rewinds the tape and stops (recording does not start again) even though TAPE END is set to REPEAT.
Timer recording does not work.	<ul style="list-style-type: none"> • Are the day and time set correctly? Set them again if not. • Are the recording start and end times and the recording mode set correctly? Confirm the settings in the Program To Record menu. • Is the timer recording indicator lit? If not, press the TIMER REC button on the front panel.
Alarm recording does not work.	<ul style="list-style-type: none"> • Is the external switch connected correctly? Check the connection. • Is the emergency recording indicator lit? Set EMERGENCY REC in the Recording Set Up menu ON.
PLAYBACK PROBLEMS	
No operation when PLAY is pressed.	<ul style="list-style-type: none"> • Is the lock or lock all indicator lit? Refer to the separate Caution sheet. See your supervisor if the sheet is not attached to this manual. • Is a cassette inserted? • Has the tape run out?
Noise bars appear in the picture during playback.	Adjust tracking by pressing the TRACKING buttons on the front panel.
Playback speed is fast or slow.	Adjust playback speed by pressing the REC/PLAY MODE buttons on the front panel.
The picture vibrates at the top and bottom when in still picture mode.	Adjust the picture by pressing the VERTICAL ADJUST buttons on the front panel.
Camera pictures are clear during recording but unclear during	The video heads may be clogged. Eject the cassette, reinsert it, and wait for more than five seconds. Repeat this step four or five times. (If you have a dry-type video playback head cleaning cassette, use it to clean the video heads. Follow the instructions carefully.) Contact your dealer if this fails to solve the problem.

SPECIFICATIONS

ELECTRICAL

Power Source:	100-230 VAC \pm 10%, 50/60 Hz (the included power cord is used for 120 VAC, 60Hz)
Power Consumption:	Approximately 20 watts

VIDEO AND AUDIO

Tape Format:	VHS, 1/2-inch width, high-density, video cassette tape
Television System:	EIA standard 525 lines, 60 fields, NTSC-type color system
Video Recording System:	Four rotary heads
Luminance Signal:	Frequency modulation recording
Color Signal:	Low frequency conversion, subcarrier phase shift recording
Audio Track:	One track
Tape Speed and Recording Time:	Refer to Table K
Fast Forward/Rewind Time:	Approx. 120 seconds with T-120 tape
Horizontal Resolution:	More than 400 lines (super resolution mode) More than 240 lines (VHS mode)
Audio Frequency Response:	70 Hz – 7 kHz (6H mode)
Signal-to-Noise Ratio:	Video: better than 42 dB Audio: better than 43 dB
Video Input/Output:	1.0 Vp-p, 75 ohms, BNC plug
Audio Input:	308 mV (rms), 50K ohms, RCA plug
Microphone Input:	0.346 mV (rms), 600 ohms, mini jack
Audio Output:	388 mV (rms), 1K ohms, RCA plug
Battery Backup:	Lasts 31 days

MECHANICAL

Heads	
Video:	Four rotary heads
Audio/Control:	One stationary head
Erase:	One full-track head
Motors:	Three direct drive (drum/capstan)
Connectors	
ALM Input:	Screw terminal for starting alarm recording
RST Input:	Screw terminal for finishing alarm recording or for adjusting on-screen clock
REC Input:	Screw terminal for starting/finishing recording or for series recording
GND:	Screw terminal for ground
ALM Output:	Screw terminal for output while alarm recording is underway
CLK Output:	Screw terminal to command camera switching
MODE Output:	Screw terminal for indicating the VCR's selected mode
CALL Output:	Screw terminal for external warning device or for series recording
REMOTE Jack:	Jack for connecting the remote control circuit
RS-232C Interface:	DB9

GENERAL

Operating Temperature:	41° to 104°F (5° to 40°C)
Relative Humidity:	Maximum 80%
Dimensions (JOG Dial Included):	16.7 (W) x 12.4 (D) x 3.7 (H) inches (42.5 x 31.4 x 9.5 cm)
Weight:	9.7 lb (4.4 kg)

Weight and dimensions show are approximate.

(Design and product specifications subject to change without notice.)

Table K. Tape Speed and Recording Time

T-120 Mode	T-160 Mode	Time (hour:min) (T-120/T-160)	Speed (mm/s)	Recording Interval (s/field)	Recording Fields per Second (fields/s)	Video Signal	Audio Signal	Tape Drive
6H (EP)	8H (EP)	6:00/8:00	11.12	0.0167	60	Continuous	Recordable	Continuous
L18H (EP)	L24H (EP)	18:00/24:00	3.71	0.050	20	Time Lapse	Recordable	Continuous (slow)
L30H (EP)	L40H (EP)	30:00/40:00	2.22	0.083	12	Time Lapse	Recordable	Continuous (slow)
48H (EP)	64H (EP)	54:00/72:00	—	0.150	6.7	Time Lapse	Not recorded	Time Lapse
72H (EP)	96H (EP)	78:00/104:00	—	0.217	4.6	Time Lapse	Not recorded	Time Lapse
96H (EP)	128H (EP)	102:00/136:00	—	0.284	3.5	Time Lapse	Not recorded	Time Lapse
120H (EP)	160H (EP)	126:00/160:00	—	0.350	2.8	Time Lapse	Not recorded	Time Lapse
168H (EP)	224H (EP)	174:00/232:00	—	0.484	2.1	Time Lapse	Not recorded	Time Lapse
0H (EP)	0H (EP)	—	—	—	—	Time Lapse	Not recorded	Time Lapse

INDEX

A

Adjusting the picture 52
Alarm list 47
Alarm recording 44
 connection 14
 search 54, 55
Alarm recording connection 44
Alarm recording duration 29
Alarm recording mode 29
Alarm start times 47
Audio playback 50
Audio recording 38

B

Background color 27
Blue back 27
Buzzer 32

C

Call out setting 30
Carriage return code 59
Check 69
Check recording 38
Clock adjustment 24
Clock out setting 30
Clog detection 29
Command chart 62
Commands from a PC 59
Connect PC for remote control 16
Connecting for alarm recording 14
Connecting for external time clock adjustment 15
Connecting for remote recording 14
Connecting for series recording 14
Connecting for synchronous recording 15
Connecting for typical setup 12
Connecting VCR to multiplexer 13
Connecting VCR to PC 16
Counter memory 57
Counter memory stop 54
Counter reset 57

D

Data bit length 33
Data comm settings 16
Date adjust setting 32
Date display size 27
Date search 56
Day (setting) 34
Day and time display modes 33
Daylight savings 34
Delimiter (receive) 33
Delimiter (send) 33
Delimiters (send and receive) 59
Direct SHUTTLE ring operation 51
Display menu 27
Display mode 27
Display modes 1 and 2 33
DW (day of week) recording 28

E

Elapsed time display 48
Emergency recording 45
Emergency recording mode 29
End 69
End recording times 28
Erase holiday setting 43
Erase program setting 42
Erasure prevention tab 35
Error codes 68
External time clock adjustment 15, 57

F

Features 9
First time set up menu 32
Flashing indicator 43
Fluorescent display 20
Frame-by-frame playback 50
Front panel controls 18

H

Holiday recording 28
Holiday recording set up 43
HR (recording mode) 28

I

Index search 55
Installation 12
Installation cautions 11
Interval recording 40

J

JOG dial operation 23

L

Language selection menu 25
Loading tape cassettes 35
Lock all button 35

M

Main menu 27
MAN1/MAN2 45
Manual recording 37
Memory backup 57
Menu tree 26
Menus
 display 27
 first time set up 32
 main 27
 program 28
 recording set up 29
Mode out setting 31
Monitor tips 11

N

No signal 69
noSIg 69

O

One shot field 29
One shot interval 29
One shot recording 40
Overlapping programs 43

P

Parity bit 33
Pause mode 37
PC cable connections 17
PC commands 59
PC connection 16
Personal computer use 58
Phone numbers 8
Picture adjustment 52
Playback procedure 49
Power failures and recording 46
Power loss list 46
Program number 28
Program overlap 43
Programming alarm recording 45
Programming procedure 25

Q

Quasi v-sync 32
Quick guide to menu structure 26

R

Rear panel connections 22
Rec in mode 31
Recording
 after power failure 46
 alarm 44
 alarm recording 45
 audio 38
 check 38
 emergency 45
 holidays 43
 interval 40
 manually 37
 mode (HR) 28
 mode and times 38
 one-shot 40
 remote 40
 repeat 38
 series 39
 special day of week settings 43
 synchronous 41
 timer 42
Recording set up menu 29
Remote recording 40
Repeat recording 38
Repeat recording times display 48
Reset button 57
Reset the counter 57
Reset tracking 52
Response chart 62
RS-232C 32
RS-232C settings 58

S

Search techniques
 counter memory 54
 index 55
 skip 54
 time and date 56
Self-diagnostic function 69
Series recording 39
SHUTTLE ring hold 52
SHUTTLE ring operation 23, 51
Skip search 54
Special DW (day of week) recording 43
Special effects playback 50
Start/end recording times 28
Still picture 50
Stop bit length 33
Super resolution 29
Synchronous recording 41

T

Tape counter 57
Tape damage 36
Tape end 50, 69
Tape end setting 32
Tape length 32
Tape loading/unloading/protecting 35
Tape replacement 36, 39
Tape uses (number of) 48
Testing the system 68
Time (setting) 34
Time and date adjust setting 32
Time and date display size 27
Time display modes 33
Time search 56
Timer program menu 28
Timer recording 42
Tracking adjustment 52
Transmission rate 33
Troubleshooting 69

U

Unloading tape cassettes 35

V

VCR address 33
VCR controls (securing) 11
Vertical adjustment 53
Vibration control 53
Video mode 32

W

Warning display 69

REGULATORY NOTICES

NOTE: This equipment has been tested and found to comply with the limits of a Class B digital device, pursuant to part 15 of the FCC rules. These limits are designed to provide reasonable protection against harmful interference in a residential installation. This equipment generates, uses, and can radiate radio frequency energy and, if not installed and used in accordance with the instructions, may cause harmful interference to radio communications. However there is no guarantee that the interference will not occur in a particular installation. If this equipment does cause harmful interference to radio or television reception, which can be determined by turning the equipment off and on, the user is encouraged to try and correct the interference by one or more of the following measures:

- Reorient or relocate the receiving antenna.
- Increase the separation between the equipment and the receiver.
- Connect the equipment into an outlet on a circuit different from that to which the receiver is connected.
- Consult the dealer or an experienced radio/TV technician for help.

PRODUCT WARRANTY AND RETURN INFORMATION

WARRANTY

Pelco will repair or replace, without charge, any merchandise proved defective in material or workmanship **for a period of one year** after the date of shipment.

Exceptions to this warranty are as noted below:

- Five years on FT/FR8000 Series fiber optic products.
- Three years on Genex® Series products (multiplexers, server, and keyboard).
- Three years on Camclosure® and fixed camera models, except the CC3701H-2, CC3701H-2X, CC3751H-2, CC3651H-2X, MC3651H-2, and MC3651H-2X camera models, which have a five-year warranty.
- Two years on standard motorized or fixed focal length lenses.
- Two years on Legacy®, CM6700/CM6800/CM9700 Series matrix, and DF5/DF8 Series fixed dome products.
- Two years on Spectra®, Esprit®, ExSite™, and PS20 scanners, including when used in continuous motion applications.
- Two years on Esprit® and WW5700 Series window wiper (excluding wiper blades).
- Eighteen months on DX Series digital video recorders, NVR300 Series network video recorders, and Endura™ Series distributed network-based video products.
- One year (except video heads) on video cassette recorders (VCRs). Video heads will be covered for a period of six months.
- Six months on all pan and tilts, scanners or preset lenses used in continuous motion applications (that is, preset scan, tour and auto scan modes).

Pelco will warrant all replacement parts and repairs for 90 days from the date of Pelco shipment. All goods requiring warranty repair shall be sent freight prepaid to Pelco, Clovis, California. Repairs made necessary by reason of misuse, alteration, normal wear, or accident are not covered under this warranty.

Pelco assumes no risk and shall be subject to no liability for damages or loss resulting from the specific use or application made of the Products. Pelco's liability for any claim, whether based on breach of contract, negligence, infringement of any rights of any party or product liability, relating to the Products shall not exceed the price paid by the Dealer to Pelco for such Products. In no event will Pelco be liable for any special, incidental or consequential damages (including loss of use, loss of profit and claims of third parties) however caused, whether by the negligence of Pelco or otherwise.

The above warranty provides the Dealer with specific legal rights. The Dealer may also have additional rights, which are subject to variation from state to state.

If a warranty repair is required, the Dealer must contact Pelco at (800) 289-9100 or (559) 292-1981 to obtain a Repair Authorization number (RA), and provide the following information:

1. Model and serial number
2. Date of shipment, P.O. number, Sales Order number, or Pelco invoice number
3. Details of the defect or problem

If there is a dispute regarding the warranty of a product which does not fall under the warranty conditions stated above, please include a written explanation with the product when returned.

Method of return shipment shall be the same or equal to the method by which the item was received by Pelco.

RETURNS

In order to expedite parts returned to the factory for repair or credit, please call the factory at (800) 289-9100 or (559) 292-1981 to obtain an authorization number (CA number if returned for credit, and RA number if returned for repair).

All merchandise returned for credit may be subject to a 20% restocking and refurbishing charge.

Goods returned for repair or credit should be clearly identified with the assigned CA or RA number and freight should be prepaid. Ship to the appropriate address below.

If you are located within the continental U.S., Alaska, Hawaii or Puerto Rico, send goods to:

Service Department
Pelco
3500 Pelco Way
Clovis, CA 93612-5699

If you are located outside the continental U.S., Alaska, Hawaii or Puerto Rico and are instructed to return goods to the USA, you may do one of the following:

If the goods are to be sent by a COURIER SERVICE, send the goods to:

Pelco
3500 Pelco Way
Clovis, CA 93612-5699 USA

If the goods are to be sent by a FREIGHT FORWARDER, send the goods to:

Pelco c/o Expeditors
473 Eccles Avenue
South San Francisco, CA 94080 USA
Phone: 650-737-1700
Fax: 650-737-0933

REVISION HISTORY

Manual #	Date	Comments
C673M	2/01	Original version.